

Liquidtight ST™ Series Plain Throat and STB Series Insulated Throat Connectors

For Liquidtight Flexible Metal Conduit

NEC/CEC — Listed for Ordinary Locations
NEC — Suitable for use in the following Hazardous Locations:
 Class I, Division 2 per NEC 501.10(B)(4)
 Class I, Zone 2 per NEC 505.15(C)(2)
 Class II, Division 1 per NEC 502.10(A)(2)(2)

NEC — Suitable for use in the following Hazardous Locations:
 Class II, Division 2 per NEC 502.10(B)(2)
 Class III, Division 1 per NEC 503.10(A)(3)(2)
 Class III, Division 2 per NEC 503.10(B)
 Intrinsically Safe per NEC 504.20

Applications

- Provides a dependable connection for liquidtight flexible metal conduit.

Features

- ST Series has plain throat.
- STB Series has insulated throat to protect against wire damage.
- Seals out oil, water, dust, dirt and fumes.
- Unique long ferrule with more pronounced threads provides over four times UL pull-out requirements.
- Ferrule provides maximum surface contact for better sealing and a continuous, permanent, positive metal-to-metal ground.
- Polypropylene sealing ring with locknut standard.
- Liquidtight/raintight/oiltight/concretetight.
- Suitable for wet locations.
- Full, machined tapered threads (NPT).
- Compact design with small turning radius.
- Straight, 45° and 90° styles available in trade sizes 3/8" thru 4"

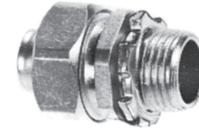

ST-38

Standard Material/Finish

- 3/8" thru 1" straight: steel body and compression nut
- 1-1/4" thru 4" straight: malleable iron body and compression nut
- 3/8" thru 4" 45° and 90°: malleable iron body
- 3/8" thru 1" 45° and 90° caps: steel
- 1-1/4" thru 4" 45° and 90° caps: malleable iron
- 3/8" thru 1" ferrule: steel
- 1-1/4" thru 4" ferrule: aluminum
- Steel: zinc electroplate
- Malleable iron: zinc electroplate, chromate and epoxy powder coat/zinc electroplate
- Sealing ring: polypropylene

NEC/CEC Certifications and Compliances

- UL Standard: 514B
- UL Listed: E-11853
- CSA Standard C22.2 No. 18.3
- CSA Certified: 065178
- NEMA: FB-1

STD Conduit Thread Size

Flexible Conduit Size (Inches)	NPT Size
3/8	1/2
1/2	1/2
3/4	3/4
1	1
1-1/4	1-1/4
1-1/2	1-1/2
2	2
2-1/2	2-1/2
3	3
3-1/2	3-1/2
4	4
5	5

Illustrated Dimensions

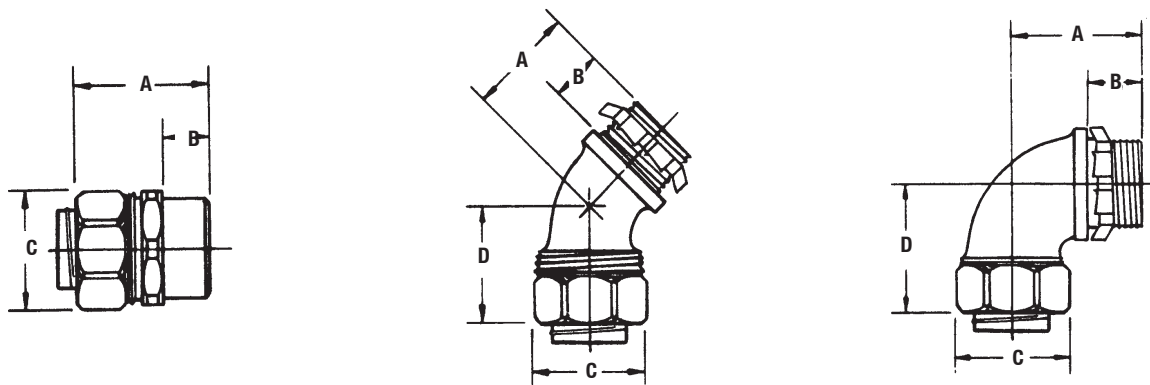

COMMERCIAL AND INDUSTRIAL FITTINGS: LIQUIDTIGHT CONDUIT FITTINGS





APPLETON™

Liquidtight ST™ Series Plain Throat and STB Series Insulated Throat Connectors

For Liquidtight Flexible Metal Conduit

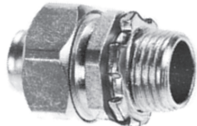
NEC/CEC — Listed for Ordinary Locations
 NEC — Suitable for use in the following
 Hazardous Locations:
 Class I, Division 2 per NEC 501.10(B)(4)
 Class I, Zone 2 per NEC 505.15(C)(2)
 Class II, Division 1 per NEC 502.10(A)(2)(2)

NEC — Suitable for use in the following
 Hazardous Locations:
 Class II, Division 2 per NEC 502.10(B)(2)
 Class III, Division 1 per NEC 503.10(A)(3)(2)
 Class III, Division 2 per NEC 503.10(B)
 Intrinsically Safe per NEC 504.20

	Conduit Size (Inches)	Dimensions in Millimeters (Inches)				Weight per 100 kg (lb)	Catalog Number
		A	B	C	D		
Straight							
	3/8 flex, 1/2 hub	36.6 (1.44)	16.0 (0.63)	28.7 (1.13)	—	7.3 (16.00)	ST-38
	1/2	36.6 (1.44)	16.0 (0.63)	31.8 (1.25)	—	6.8 (15.00)	ST-50
	3/4	38.1 (1.50)	16.0 (0.63)	38.1 (1.50)	—	10.0 (22.00)	ST-75
	1	41.4 (1.63)	19.1 (0.75)	45.9 (1.81)	—	15.4 (34.00)	ST-100
	1-1/4	50.8 (2.00)	16.0 (0.63)	58.7 (2.31)	—	38.1 (84.00)	ST-125
	1-1/2	57.2 (2.25)	16.0 (0.63)	66.8 (2.63)	—	54.4 (120.00)	ST-150
	2	63.5 (2.50)	17.5 (0.69)	81.0 (3.19)	—	74.8 (165.00)	ST-200
	2-1/2	85.9 (3.38)	26.9 (1.06)	100.1 (3.94)	—	158.8 (350.00)	ST-250
	3	93.7 (3.69)	30.2 (1.19)	111.3 (4.38)	—	204.1 (450.00)	ST-300
	3-1/2	93.7 (3.69)	30.2 (1.19)	127 (5.00)	—	238.1 (525.00)	ST-350
	4	101.6 (4.00)	31.8 (1.25)	139.7 (5.50)	—	301.2 (664.00)	ST-400
45°							
	3/8 flex, 1/2 hub	22.4 (0.88)	16.0 (0.63)	28.7 (1.13)	28.7 (1.13)	19.0 (8.62)	ST-4538
	1/2	22.4 (0.88)	16.0 (0.63)	31.8 (1.25)	28.7 (1.13)	19.0 (8.62)	ST-4550
	3/4	28.7 (1.13)	16.0 (0.63)	45.9 (1.81)	31.8 (1.25)	32.0 (14.51)	ST-4575
	1	35.1 (1.38)	19.1 (0.75)	45.9 (1.81)	45.9 (1.81)	46.0 (20.87)	ST-45100
	1-1/4	41.4 (1.63)	16.0 (0.63)	58.7 (2.31)	45.9 (1.81)	103.0 (46.72)	ST-45125
	1-1/2	45.9 (1.81)	16.0 (0.63)	66.8 (2.63)	54.1 (2.13)	165.0 (74.84)	ST-45150
	2	50.8 (2.00)	17.5 (0.69)	81.0 (3.19)	60.5 (2.38)	245.0 (111.13)	ST-45200
	2-1/2	90.4 (3.56)	26.9 (1.06)	100.1 (3.94)	127.0 (5.00)	760.0 (344.73)	ST-45250
	3	109.5 (4.31)	30.2 (1.19)	111.3 (4.38)	147.6 (5.81)	962.0 (436.36)	ST-45300
	4	117.6 (4.63)	31.8 (1.25)	5.5 (139.7)	101.6 (4.00)	1512.0 (685.83)	ST-45400
90°							
	3/8 flex, 1/2 hub	31.8 (1.25)	16.0 (0.63)	28.6 (1.13)	36.5 (1.44)	10.3 (22.80)	ST-9038
	1/2	33.3 (1.31)	16.0 (0.63)	31.8 (1.25)	36.8 (1.45)	10.3 (23.00)	ST-9050
	3/4	36.6 (1.44)	16.0 (0.63)	38.9 (1.53)	43.2 (1.70)	17.7 (39.00)	ST-9075
	1	44.5 (1.75)	19.1 (0.75)	45.9 (1.81)	49.5 (1.95)	28.1 (62.00)	ST-90100
	1-1/4	45.9 (1.81)	16.0 (0.63)	58.7 (2.31)	60.5 (2.38)	51.7 (114.00)	ST-90125
	1-1/2	61.9 (2.44)	16.0 (0.63)	66.8 (2.63)	81.0 (3.19)	88.5 (195.00)	ST-90150
	2	66.8 (2.63)	17.5 (0.69)	81.0 (3.19)	90.4 (3.56)	131.5 (290.00)	ST-90200
	2-1/2	182.6 (7.19)	26.9 (1.06)	100.1 (3.94)	214.4 (8.44)	382.4 (843.00)	ST-90250
	3	219.2 (8.63)	30.2 (1.19)	111.3 (4.38)	257.3 (10.13)	499.0 (1100.00)	ST-90300
	4	285.8 (11.25)	31.8 (1.25)	139.7 (5.50)	325.4 (12.81)	952.5 (2100.00)	ST-90400

COMMERCIAL AND INDUSTRIAL FITTINGS: LIQUIDTIGHT CONDUIT FITTINGS



APPLETON™

Liquidtight ST™ Series Plain Throat and STB Series Insulated Throat Connectors

For Liquidtight Flexible Metal Conduit

NEC/CEC — Listed for Ordinary Locations
 NEC — Suitable for use in the following
 Hazardous Locations:
 Class I, Division 2 per NEC 501.10(B)(4)
 Class I, Zone 2 per NEC 505.15(C)(2)
 Class II, Division 1 per NEC 502.10(A)(2)(2)

NEC — Suitable for use in the following
 Hazardous Locations:
 Class II, Division 2 per NEC 502.10(B)(2)
 Class III, Division 1 per NEC 503.10(A)(3)(2)
 Class III, Division 2 per NEC 503.10(B)
 Intrinsically Safe per NEC 504.20

	Conduit Size (Inches)	Dimensions in Millimeters (Inches)				Weight per 100 kg (lb)	Catalog Number
		A	B	C	D		
Straight							
	3/8 flex, 1/2 hub	36.6 (1.44)	16.0 (0.63)	28.7 (1.13)	—	6.8 (15.00)	STB-38
	1/2	36.6 (1.44)	16.0 (0.63)	31.8 (1.25)	—	7.3 (16.00)	STB-50
	3/4	38.1 (1.50)	16.0 (0.63)	38.1 (1.50)	—	10.4 (23.00)	STB-75
	1	41.4 (1.63)	19.1 (0.75)	45.9 (1.81)	—	15.4 (34.00)	STB-100
	1-1/4	50.8 (2.00)	16.0 (0.63)	58.7 (2.31)	—	38.1 (84.00)	STB-125
	1-1/2	57.2 (2.25)	16.0 (0.63)	66.8 (2.63)	—	54.0 (119.00)	STB-150
	2	63.5 (2.50)	17.5 (0.69)	81.0 (3.19)	—	77.1 (170.00)	STB-200
	2-1/2	85.9 (3.38)	26.9 (1.06)	100.1 (3.94)	—	154.2 (340.00)	STB-250
	3	93.7 (3.69)	30.2 (1.19)	111.3 (4.38)	—	204.1 (450.00)	STB-300
	3-1/2	93.7 (3.69)	30.2 (1.19)	27.0 (5.00)	—	240.4 (530.00)	STB-350
4	101.6 (4.00)	31.8 (1.25)	139.7 (5.50)	—	297.1 (655.00)	STB-400	
45°							
	3/8 flex, 1/2 hub	22.4 (0.88)	16.0 (0.63)	28.7 (1.13)	28.7 (1.13)	8.2 (18.00)	STB-4538
	1/2	22.4 (0.88)	16.0 (0.63)	31.8 (1.25)	28.7 (1.13)	8.2 (18.00)	STB-4550
	3/4	28.7 (1.13)	16.0 (0.63)	45.9 (1.81)	31.8 (1.25)	13.6 (30.00)	STB-4575
	1	35.1 (1.38)	19.1 (0.75)	45.9 (1.81)	45.9 (1.81)	22.2 (49.00)	STB-45100
	1-1/4	41.4 (1.63)	16.0 (0.63)	58.7 (2.31)	45.9 (1.81)	46.3 (102.00)	STB-45125
	1-1/2	45.9 (1.81)	16.0 (0.63)	66.8 (2.63)	54.1 (2.13)	72.6 (160.00)	STB-45150
	2	50.8 (2.00)	17.5 (0.69)	81.0 (3.19)	60.5 (2.38)	104.3 (230.00)	STB-45200
	2-1/2	90.4 (3.56)	26.9 (1.06)	100.1 (3.94)	127.0 (5.00)	344.7 (760.00)	STB-45250
	3	109.5 (4.31)	30.2 (1.19)	111.3 (4.38)	147.6 (5.81)	453.6 (1000.00)	STB-45300
	4	117.6 (4.63)	31.8 (1.25)	5.50 (139.7)	101.6 (4.00)	816.5 (1800.00)	STB-45400
90°							
	3/8 flex, 1/2 hub	31.8 (1.25)	16.0 (0.63)	28.7 (1.13)	38.1 (1.50)	10.4 (23.00)	STB-9038
	1/2	31.8 (1.25)	16.0 (0.63)	31.8 (1.25)	38.1 (1.50)	10.9 (24.00)	STB-9050
	3/4	36.6 (1.44)	16.0 (0.63)	38.1 (1.50)	39.6 (1.56)	17.2 (38.00)	STB-9075
	1	35.1 (1.38)	19.1 (0.75)	45.9 (1.81)	47.8 (1.88)	26.31 (58.00)	STB-90100
	1-1/4	45.9 (1.81)	16.0 (0.63)	58.7 (2.31)	60.5 (2.38)	52.62 (116.00)	STB-90125
	1-1/2	61.9 (2.44)	16.0 (0.63)	66.8 (2.63)	81.0 (3.19)	87.09 (192.00)	STB-90150
	2	66.8 (2.63)	17.5 (0.69)	81.0 (3.19)	90.4 (3.56)	127.91 (282.00)	STB-90200
	2-1/2	182.6 (7.19)	26.9 (1.06)	100.1 (3.94)	214.4 (8.44)	381.02 (840.00)	STB-90250
	3	219.2 (8.63)	30.2 (1.19)	111.3 (4.38)	257.3 (10.13)	498.95 (1100.00)	STB-90300
	4	285.8 (11.25)	31.8 (1.25)	139.7 (5.50)	325.4 (12.81)	975.22 (2150.00)	STB-90400

COMMERCIAL AND INDUSTRIAL FITTINGS: LIQUIDTIGHT CONDUIT FITTINGS

APPLETON™