

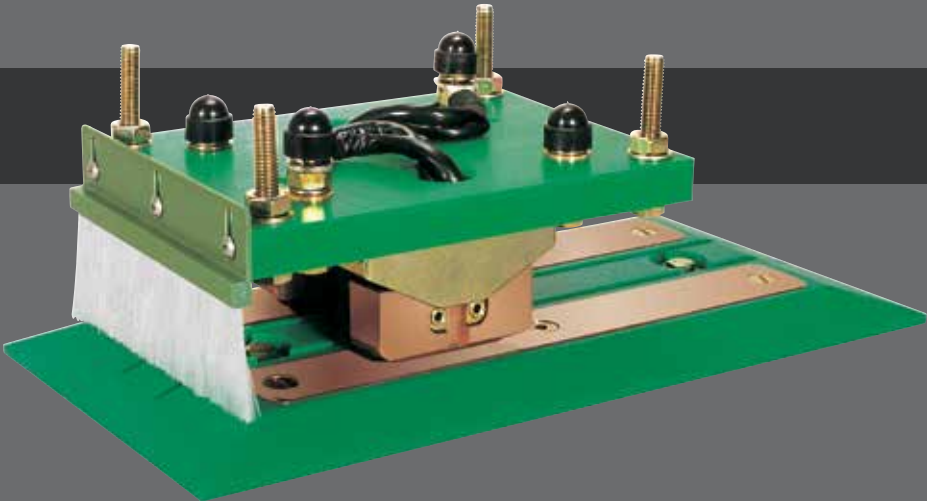

Charging Contacts - BLS/BLK



# CHARGING CONTACTS - BLS/BLK

## TABLE OF CONTENTS

**General** ..... 2  
**Models** ..... 4  
**Spare parts list** ..... 9  
**General installation instructions** ..... 10

Automatic Guided Vehicles (AGVs) offer their users a highly versatile solution for demanding manufacturing, material handling and production applications. To meet application demands, AGVs often operate continuously with little flexibility for down time. Often, recharging the batteries required for this amount of movement presents a problem.

To address this issue, AGV manufacturers have developed powerful batteries which can be quickly recharged within seconds. To optimize this ability, VAHLE has developed highly versatile charging contacts that can be installed anywhere along the production cycle – allowing battery charging without removing the AGVs from production processes.

Battery charging stations may be installed anywhere within the AGV path where the production process allows a stop – staging areas, turn arounds, loading stops, etc. To fully provide the best possible integration within a given layout, VAHLE offers a wide range of standard charging contacts along with the ability to custom tailor an exact solution to your needs.

A battery charging contact consists of a base plate, which can be installed on the floor or laterally adjacent to the AGV path, and a collector which is installed on the vehicle. These contacts can be integrated with a battery charging system, which controls the current to the AGV once the collector and baseplate have made contact.

The standard base plates have chamfered entry/exit ramps to facilitate smooth drive-on/drive-off of the spring loaded collector. Depending on application requirements, different entry/exit angles are available for select models or on custom pieces. Additionally, some collectors offer the use of bristle brushes, to remove debris upon contact with the base plate.

VAHLE charging contacts are designed for a voltage of 12-80 V. Nominal voltages > 25 V AC or 60 V DC require a protection against accidental touch.

In addition to AGV battery charging, VAHLE charging contacts can be effectively utilized in a variety of applications such as automated parking garages, amusement rides and AS/RS shuttles. Contact VAHLE today to learn more about the wide range of products and services offered.

**AGV: 12 units**  
**Charging stations: 4 units**  
**Batteries: 12 units**  
**3-Shift-Operation**

- 1 = Loading stop
- 2 = Assembly Place
- 3 = Hand-over area
- 4 = AGV staging area
- 5 = Charging stations
- 6 = Buffer store and floor mounted charging contacts

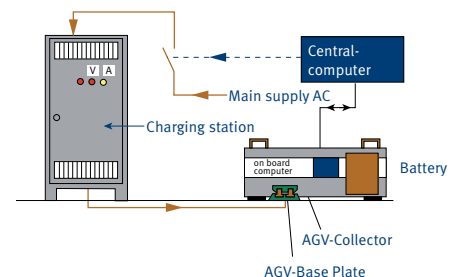
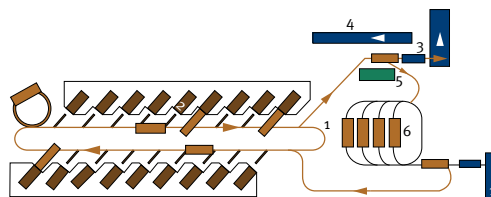

**Schematic layout of power supply for Automatic Guided Vehicles (AGVs)**



# MODELS

## COLLECTORS & BASE PLATES

### COLLECTOR

#### 2-PHASE, 200 A

Insulated collector for vehicle installation, with two contact brushes and a bristle cleaning brush.

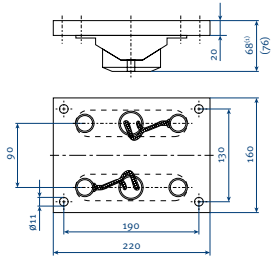

Type	Weight/kg (lbs)	Cat.-No
BLS 200-2-01	2.600 (5.7)	590 000

### BASE PLATE

#### 2-PHASE, 200 A

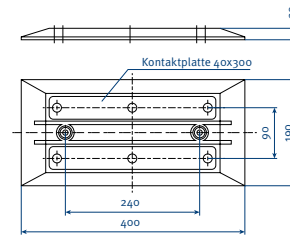

Type	Weight/kg (lbs)	Cat.-No
BLK 200-2-01	2.200 (4.9)	590 001

### COLLECTOR

#### 2-PHASE, 200 A

Insulated collector for vehicle installation, with two contact brushes, surrounding bristle cleaning brushes and two-directional drive-on capability

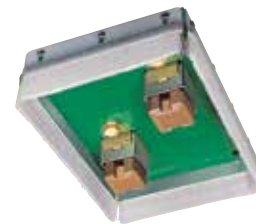
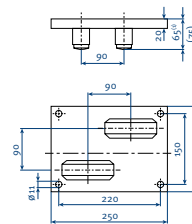

Type	Weight/kg (lbs)	Cat.-No
BLS 200-2Q-01	3.500 (7.7)	590 013

(1) Height at contact position

# MODELS

## COLLECTOR

### 2-PHASE, 200 A

Insulated collector for vehicle installation, with two contact brushes each for charging, two pilot contacts and a bristle cleaning brush

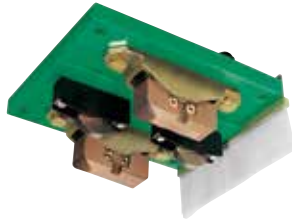
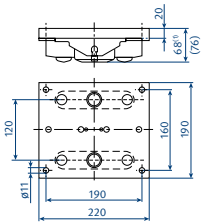

Type	Weight/kg (lbs)	Cat.-No
BLS 200-2B/20-2-01	3.000 (6.6)	590 198

## BASE PLATE

### 2-PHASE, 200 A

Insulated floor contact plate with two copper contact plates for charging and two pilot copper contact plates

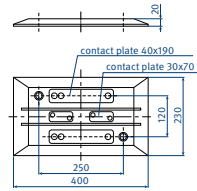

Type	Weight/kg (lbs)	Cat.-No
BLK 200-2/25-2-01	2.700 (6.0)	590 062

## COLLECTOR

### 2-PHASE, 200 A

Insulated collector for vehicle installation, with two contact brushes and cover pusher

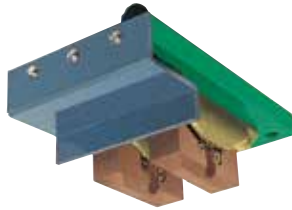
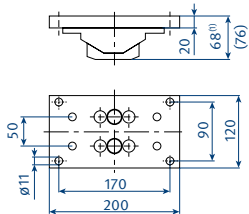

Type	Weight/kg (lbs)	Cat.-No
BLS 200-2E-01	2.260 (5.0)	590 065

## BASE PLATE

### 2-PHASE, 200 A

Insulated floor contact plate with two copper contacts, spring loaded cover and 2 x 2 m connecting cables

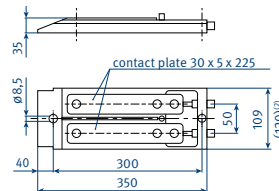

Type	Weight/kg (lbs)	Cat.-No
BLK 200-2EA-01	3.926 (8.7)	590 064

(1) Height at contact position  
(2) Dimensions incl. coverage

# MODELS

## COLLECTORS & BASE PLATES

### COLLECTOR SINGLE-PHASE, 200A

Insulated collector for vehicle installation, with one contact brush and one bristle cleaning brush (to be used in pairs)

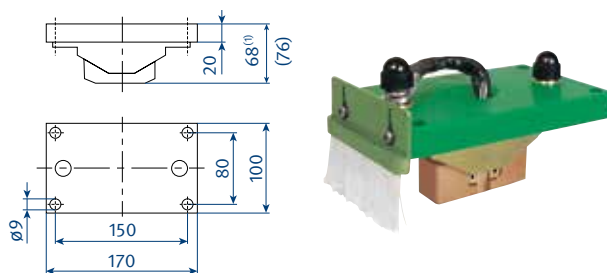

Type	Weight/kg (lbs)	Cat.-No
BLS 200-1-04	1.362 (3.0)	590 035

### BASE PLATE SINGLE-PHASE, 200A

Insulated floor contact plate, complete with single copper contact

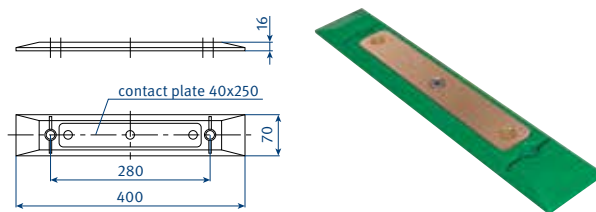

Type	Weight/kg (lbs)	Cat.-No
BLK 200-1-01 W	0.890 (2.0)	590 036

### COLLECTOR SINGLE-PHASE, 200A

Insulated collector for vehicle installation, reduced footprint model

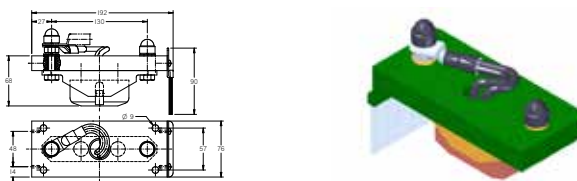

Type	Weight/kg (lbs)	Cat.-No
BLS 200-1-09	1.225 (2.7)	590 301

(1) Height at contact position

# MODELS

## COLLECTOR 2-PHASE, 20 A

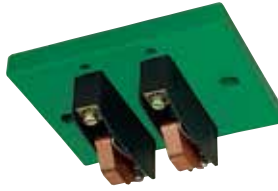
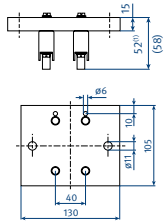

Type	Weight/kg (lbs)	Cat.-No
BLS 20-20-01	0.310 (0.7)	590 207

## BASE PLATE 2-PHASE, 25 A

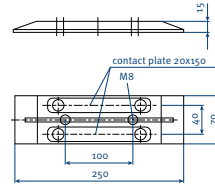

Type	Weight/kg (lbs)	Cat.-No
BLK 25-2-01	0.590 (1.3)	590 042

## COLLECTOR 2-PHASE, 25 A

Insulated collector for vehicle installation, with two compression contact brushes

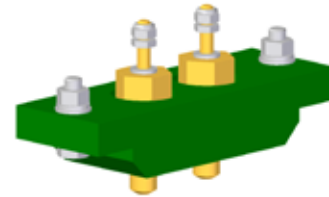
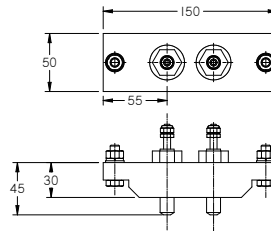

Type	Weight/kg (lbs)	Cat.-No
BLS 25-2-01	0.454 (1.0)	590 041

(1) Height at contact position

# MODELS

## COLLECTORS & BASE PLATES

### COLLECTOR SINGLE-PHASE, 400 A

Insulated collector for vehicle installation, with 2 contact brushes

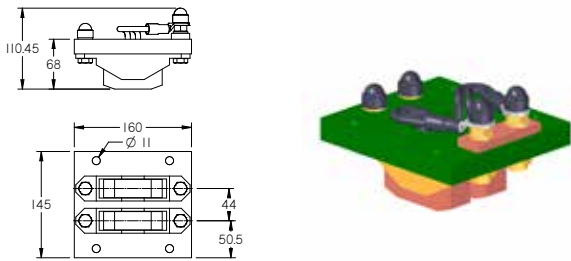

Type	Weight/kg (lbs)	Cat.-No
BLS 400-1-02	1.362 (3.0)	590 114

### BASE PLATE SINGLE-PHASE, 400 A

Insulated floor contact plate with single copper contact

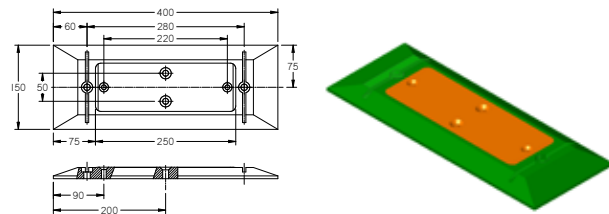

Type	Weight/kg (lbs)	Cat.-No
BLK 400-1-02	1.950 (4.3)	590 115

### COLLECTOR SINGLE-PHASE, 600 A

Insulated collector for vehicle installation, with three contact brushes and one bristle cleaning brush (to be used in pairs)

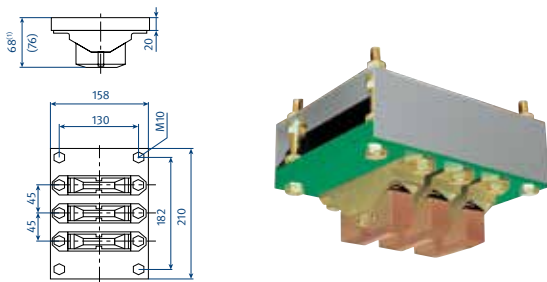

Type	Weight/kg (lbs)	Cat.-No
SA-BLS600-1A0-01	4.100 (9.0)	590 043

### BASE PLATE SINGLE-PHASE, 600 A

Insulated floor contact plate, complete with single copper contact

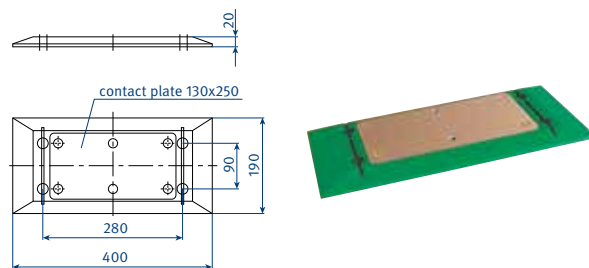

Type	Weight/kg (lbs)	Cat.-No
BLK600-1-01	3.000 (6.6)	590 044

(1) Height at contact position

# SPARE PARTS LIST

## FOR STANDARD COLLECTORS AND BASE PLATES

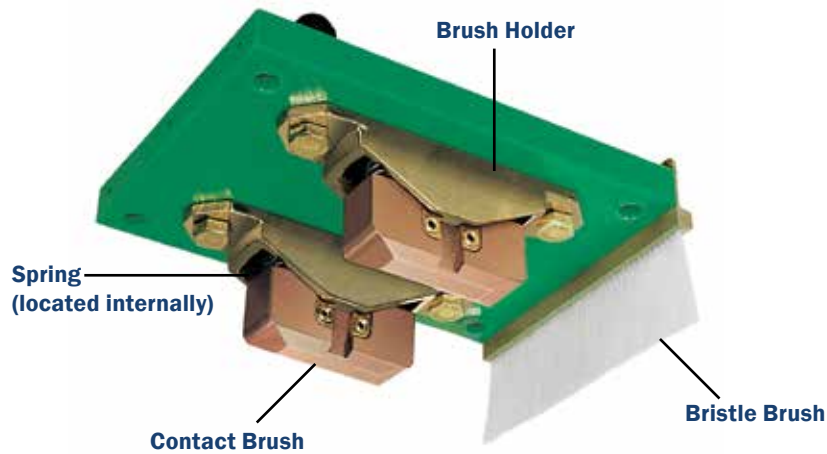

Part Number	Description	For Cat.-No(s)
590 002	BLS 200A Brush	590 000, 590 198, 590 035, 590 043, 590 065, 590 114
590 003	Pressure Spring	590 000, 590 198, 590 035, 590 043, 590 065, 590 114
590 004	Brush Holder	590 000, 590 198, 590 035, 590 043, 590 065, 590 114
166 614	ONST Brush (includes brush, spring and holder)	590 198
166 546	ONST Brush (includes brush, spring and holder)	590 001
590 194	BLS ST 200-Q (includes brush, spring and holder)	590 013
590 133	Bristle Brush	590 013
590 120	Bristle Brush	590 013
590 005	Bristle Brush	590 001
590 163	Bristle Brush	590 198
590 049	Bristle Brush	590 036
590 077	Compression Brush	590 041

# GENERAL INSTALLATION INSTRUCTIONS

- Install AGV-collectors on vehicle with bristle cleaning brushes in direction of travel.
- Install AGV-Base Plate on top of the floor.
- The marked height<sup>1</sup> 68 (65, 45) of AGV-Collectors type BLS is the dimension<sup>2</sup> at contact position. Allowable tolerance: + 2 mm.
- In order to guarantee sufficient contact pressure, the max. wear reduction of the contact brushes is limited to 5 mm whereby the unevenness of the floor must be considered.
- Between base plate and cutout at concrete floor a dust- and waterproof sealing has to be installed.

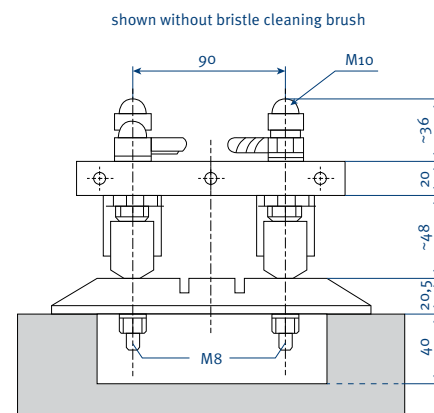
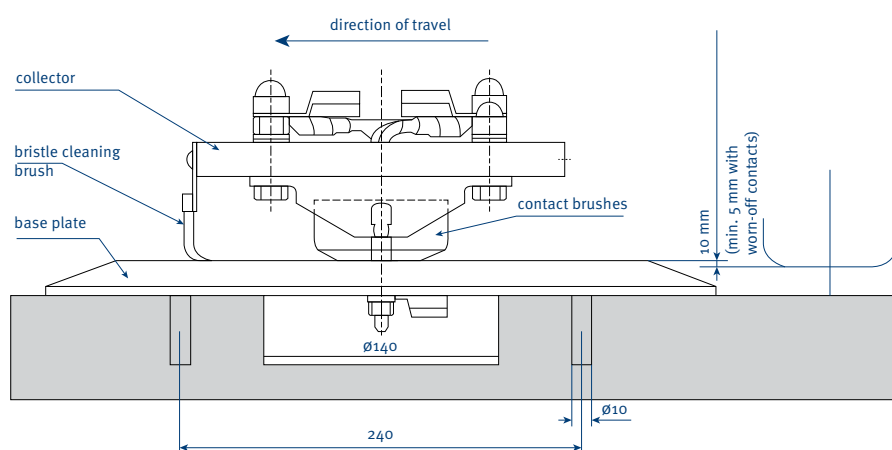

(1) Height at contact position  
 (2) Dimensions incl. coverage