



## Flexibility and Safety

BERNSTEIN safety hinge switches

# Safety solutions for automation engineering



## Our expertise for your safety

In the field of industrial automation engineering, safety technology is becoming ever increasingly important. Stricter Health and Safety regulations intensifies the responsibility of the machine builder to protect the individual from the machine – our safety hinge switches offer a complete and safe solution to this need.

BERNSTEIN is one of the world's leading provider of industrial safety technology. We deliver solutions in the lift, construction, automotive, plant/machinery construction, and of course automation engineering.

## BERNSTEIN safety hinge switches



### Advantages of safety hinge switches in comparison to traditional door contacts

- Easy to install and tamper-resistant
- No actuator necessary
- Reliably operating
- Little risk of injury

# Safety Switches for Hinged



## SHS Safety hinge switches

- Die-cast zinc metal housing
- 1 positive opening safety contact
- Safety device ensures positive locking after the switch has been set

## SHS3 / Double hinge switch SHS3 Safety hinge switches

- Stainless steel hinge
- Freely and repeatedly adjustable switching point
- 2 positive opening safety contacts with additional normally-open signalling contact
- For arduous applications (Food & Beverage industry or heavy hinged protective equipment)
- Double hinge version with two switches available

# Protective Equipment



**SHS3 stainless steel  
version also with IP 69K**

## **SHS3Z Safety hinge switches**

- Die-cast zinc hinge
- Freely and repeatedly adjustable switching point
- 2 positive opening safety contacts with additional normally-open signalling contact
- For standard applications

# Stainless steel SHS3 / Die-cast zinc SHS3Z Safety hinge switch



## Safe

With suitable system layout, the switch can be used up to performance level e. Following variants are available:

- 2 positive opening safety contacts
- 2 positive opening safety contacts with additional normally-open signalling contact
- Integrated AS interface Safety at Work.

### Switching diagram

#### U15Z

2 NC contacts,  
1 NO contact (Zb)

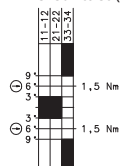

#### A2Z

2 NC contacts (Zb)

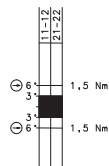

## Fast

- Possibility of cable connection using Ultra-Lock technology

## Reliable

- IP 67
- Stainless steel version also with IP 69K
- Load-bearing hinge made from stainless steel or die-cast zinc
- Switching system housed in a high quality plastic enclosure

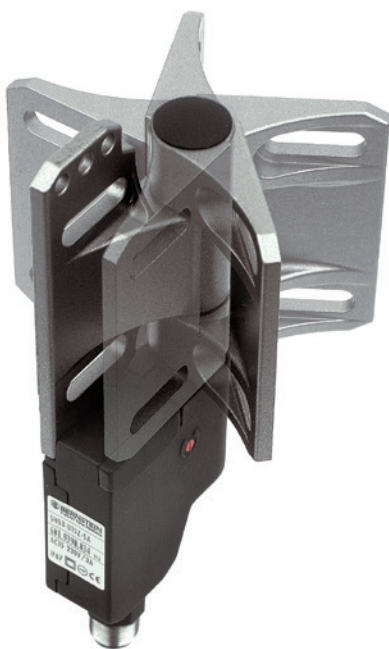

## Flexible

- Freely and repeatedly adjustable switching point
- Switching point freely adjustable by user over a range of 270°
- Uncomplicated re-adjustment even of set switching point by  $\pm 1.5^\circ$  thanks to integrated fine adjustment system
- Slots for mounting on sections and welded structures
- Plug connector and fixed cable connections are available for axial and radial (rear) connection
- Right and left hinged systems possible for optimum cable routing
- Mounting between sections while maintaining the required finger guard gap

## Double hinge

Thanks to its two switching elements on one hinge, the BG (occupational health and safety)-approved variant of the SHS3 provides two independently adjustable switching points.

This arrangement not only makes it possible to monitor the opening of a safety guard but also the direction of opening of swing doors. Of course, you have also all standard hinge switch advantages.

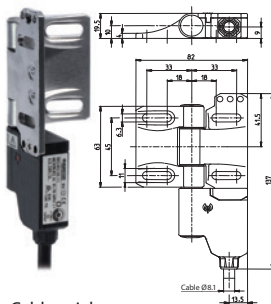

Cable axial  
Installation position  
on the left side

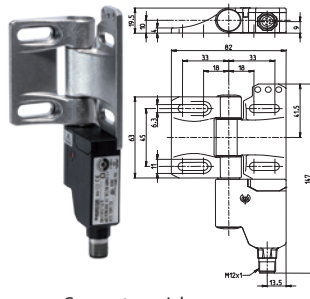

Connector axial  
Installation position  
on the right side

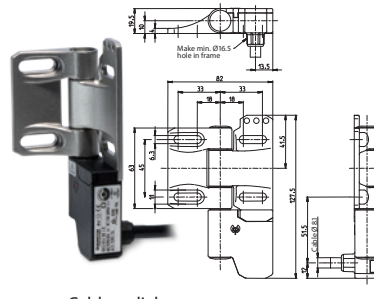

Cable radial  
Installation position  
on the right side

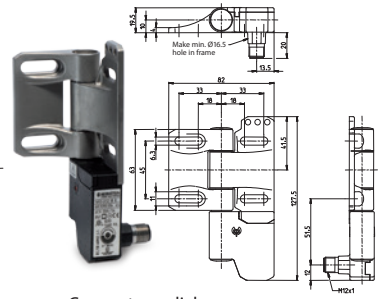

Connector radial  
Installation position  
on the right side

## Product selection for die-cast zinc version

Article number	Designation	Switching contact	Max. switching voltage	Type of voltage	Type of connection and direction radial	axial	Required cable coupling / type	Mounting
6019490050	SHS3Z-U15Z-KA5 R	2Ö/1S	230 V	AC/DC		Cable		Right
6019490051	SHS3Z-U15Z-KA5 L	2Ö/1S	230 V	AC/DC		Cable		Left
6019490052	SHS3Z-U15Z-KR5 R	2Ö/1S	230 V	AC/DC	Cable			Right
6019490053	SHS3Z-U15Z-KR5 L	2Ö/1S	230 V	AC/DC	Cable			Left
6019490054	SHS3Z-U15Z-SA R	2Ö/1S	230 V	AC/DC		M12	D	Right
6019490055	SHS3Z-U15Z-SA L	2Ö/1S	230 V	AC/DC		M12	D	Left
6019490056	SHS3Z-U15Z-SR R	2Ö/1S	230 V	AC/DC	M12		D	Right
6019490063	SHS3Z-U15Z-SR L	2Ö/1S	230 V	AC/DC	M12		D	Left
6019490057	SHS3Z-U1Z-SA R	1Ö/1S	230 V	AC/DC		M12	E	Right
6019490058	SHS3Z-U1Z-SA L	1Ö/1S	230 V	AC/DC		M12	E	Left
6019490059	SHS3Z-U1Z-SR R	1Ö/1S	230 V	AC/DC	M12		E	Right
6019490060	SHS3Z-A2Z-SA R	2Ö	230 V	AC/DC		M12	E	Right
6019490061	SHS3Z-A2Z-SA L	2Ö	230 V	AC/DC		M12	E	Left
6019490062	SHS3Z-A2Z-SR R	2Ö	230 V	AC/DC	M12		E	Right
6019490049	SHS3Z-Hinge	(blank hinge)						Both sides

## Product selection for stainless steel version

Article number	Designation	Switching contact	Max. switching voltage	Type of voltage	Type of connection and direction radial	axial	Required cable coupling / type	Mounting
6019390023	SHS3-U15Z-KA 5 L	2Ö/1S	230 V	AC/DC		Cable		Left
6019390022	SHS3-U15Z-KA 5 R	2Ö/1S	230 V	AC/DC		Cable		Right
6019390025	SHS3-U15Z-KR 5 L	2Ö/1S	230 V	AC/DC	Cable			Left
6019390024	SHS3-U15Z-KR 5 R	2Ö/1S	230 V	AC/DC	Cable			Right
6019390035	SHS3-U15Z-SA L	2Ö/1S	230 V	AC/DC		M12	D	Left
6019390034	SHS3-U15Z-SA R	2Ö/1S	230 V	AC/DC		M12	D	Right
6019390037	SHS3-U15Z-SR L	2Ö/1S	230 V	AC/DC	M12		D	Left
6019390036	SHS3-U15Z-SR R	2Ö/1S	230 V	AC/DC	M12		D	Right
6019390040	SHS3-A2Z-SA-R	2Ö	230 V	AC/DC		M12	E	Right
6019390041	SHS3-A2Z-SA-L	2Ö	230 V	AC/DC		M12	E	Left
6019390044	SHS3-A2Z-SR-R	2Ö	230 V	AC/DC	M12		E	Right
6019390042	SHS3-U1Z-SA-R	1Ö/1S	230 V	AC/DC		M12	E	Right
6019390043	SHS3-U1Z-SA-L	1Ö/1S	230 V	AC/DC		M12	E	Left
6019390045	SHS3-U1Z-SR-R	1Ö/1S	230 V	AC/DC	M12		E	Right
6019390046	SHS3-2-SA/2-SA	2 x 2Ö	230 V	AC/DC		M12	2xE	Both sides
6019390047	SHS3-5-SA/5-SA	2 x 1Ö/1S	230 V	AC/DC		M12	2xE	Both sides
6019390048	SHS3-7-KA5/7-KA5	2 x 1Ö/1S	230 V	AC/DC		Kabel		Both sides
6019390039	SHS3-7-SA/7-SA	2 x 1Ö/1S	230 V	AC/DC		M12	2xD	Both sides
6019390038	SHS3-Hinge	(blank hinge)						Both sides

## Product selection for stainless steel version with IP 69K

Article number	Designation	Switching contact	Max. switching voltage	Type of voltage	Type of connection and direction radial	axial	Required cable coupling / type	Mounting
6019390064	SHS3-U15Z-KA5-R-IPX	2Ö/1S	230 V	AC/DC		Cable		Right
6019390065	SHS3-U15Z-KA5-L-IPX	2Ö/1S	230 V	AC/DC		Cable		Left
6019390066	SHS3-U15Z-KR5-R-IPX	2Ö/1S	230 V	AC/DC	Cable			Right
6019390067	SHS3-U15Z-KR5-L-IPX	2Ö/1S	230 V	AC/DC	Cable			Left
6019390068	SHS3-7-KA5-IPX/ 7-KA5-IPX	2 x 1Ö/1S	230 V	AC/DC		Cable		Both sides



## Accessories

SHS3 Cable Type D						
Article number	Designation	Cable length	Connector type	Number of pins	Special feature	
3251006291	AN-KAB.SH53 2M STRAIGHT	2 m	Straight	6	M12 BG version	
3251006292	AN-KAB.SH53 5M STRAIGHT	5 m	Straight	6	M12 BG version	
3251006293	AN-KAB.SH53 10M STRAIGHT	10 m	Straight	6	M12 BG version	
3251006294	AN-KAB.SH53 2M ELBOW	2 m	Elbow	6	M12 BG version	
3251006295	AN-KAB.SH53 5M ELBOW	5 m	Elbow	6	M12 BG version	
3251006296	AN-KAB.SH53 10M ELBOW	10 m	Elbow	6	M12 BG version	

Contact assignments, AC/DC versions	
 <p>1 = White 2 = Brown 3 = Green 4 = Yellow 5 = Grey 6 = Pink</p>	Core insulation/sheathing material: PVC (Ø 5,6 mm)
	Moulding/contact carrier material: PUR Elastollan R3000
	Max. rated voltage: 250 V AC
	Max. current carrying capacity: 2,5 A (at 70°C)
	Min./max. temperature range: -5 °C to +105 °C (moved)
	-40 °C to +105 °C (moved firmly)
	Cable configuration mm <sup>2</sup> : LiYwUL2517 6 x 0,34
Protection class when assembled: IP 68	

SHS3 Cable Type E						
Article number	Designation	Cable length	Connector type	Number of pins	Special feature	
3251004310	AN-KAB.SH53 4P 2M STRAIGHT	2 m	Straight	4	M12 BG version	
3251004311	AN-KAB.SH53 4P 5M STRAIGHT	5 m	Straight	4	M12 BG version	
3251004312	AN-KAB.SH53 4P 10M STRAIGHT	10 m	Straight	4	M12 BG version	
3251004313	AN-KAB.SH53 4P 2M ELBOW	2 m	Elbow	4	M12 BG version	
3251004314	AN-KAB.SH53 4P 5M ELBOW	5 m	Elbow	4	M12 BG version	
3251004315	AN-KAB.SH53 4P 10M ELBOW	10 m	Elbow	4	M12 BG version	
3251004316	AN-KAB.SH53 4P U.L. 2M STRAIGHT	2 m	Gerade	4	Ultra Lock BG version	
3251004317	AN-KAB.SH53 4P U.L. 5M STRAIGHT	5 m	Gerade	4	Ultra Lock BG version	
3251004318	AN-KAB.SH53 4P U.L. 10M STRAIGHT	10 m	Gerade	4	Ultra Lock BG version	
3251004319	AN-KAB.SH53 4P U.L. 2M ELBOW	2 m	Elbow	4	Ultra Lock BG version	
3251004320	AN-KAB.SH53 4P U.L. 5M ELBOW	5 m	Elbow	4	Ultra Lock BG version	
3251004321	AN-KAB.SH53 4P U.L. 10M ELBOW	10 m	Elbow	4	Ultra Lock BG version	

Contact assignments, AC/DC versions	
 <p>1 = White 2 = Brown 3 = Blue 4 = Black</p>	Core insulation/sheathing material: Heat resistant PVC UL 1731 / UL 2517 black
	Moulding/contact carrier material: APEX 7500-85 / R3000 Elastollan R3000 neutral
	Max. rated voltage: 250 V
	Max. current carrying capacity: 4 A
	Min./max. temperature range: At rest -25 °C to +105 °C
	Moved -5 °C to +105 °C
	Protection class when assembled: IP 68

Change kit for re-adjusting switching point		Installation tool	
	<b>Article number</b>		<b>Article number</b>
	<b>3991990161</b>		<b>1910000005</b>
	SHS3 change kit containing:		Bit holder 1/4" flexible stem
	2 replacement caps 1 special bit 1 plastic ring		

## Technical Data SHS3 / SHS3Z

- Rated insulation voltage U<sub>i</sub> 250 V
- Rated operating voltage U<sub>e</sub> 240 V AC ; 24 V DC
- Conv. thermal current I<sub>the</sub> 5 A (KA/KR) ; 4 A (SA/SR)
- Utilization category / switching capacity:  
AC-15, 230 V / 3 A ; DC-13, 24 V / 1 A
- Mechanical service life 1 x 10<sup>6</sup> switching cycles
- Mechanical switching frequency max. ≤ 300/h
- B10d: 2 x 10<sup>6</sup> million
- Ambient temperature -25 °C to +70 °C  
(connection cable installed)
- Protection class IP 67 in accordance with IEC/EN 60529
- Mechanical load:  
Stainless steel: F<sub>R1</sub> = max. 1800 N ; F<sub>R2</sub> = 750 N ; F<sub>A</sub> = 1800 N  
Die-cast zinc: F<sub>R1</sub> = max. 1200 N ; F<sub>R2</sub> = 500 N ; F<sub>A</sub> = 1200 N

# Safety Hinge Switch SHS

## Safe

- System up to performance level e:  
2 SHS, each equipped with a positively opening safety contact

## Flexible

- The angle range extends from 0° to 225°
- Safety device ensures positive locking after the switch has been set
- Plug connector and fixed cable connections are available for axial and radial (rear) connection

## Fast

- AC/DC version (up to 250 V) or DC version (up to 60 V) available, depending on the configuration of the safety circuit

## Reliable

- Pressure die-cast zinc enclosure allows versatile use of the SHS switch in varied applications
- IP 67



### Switching diagram

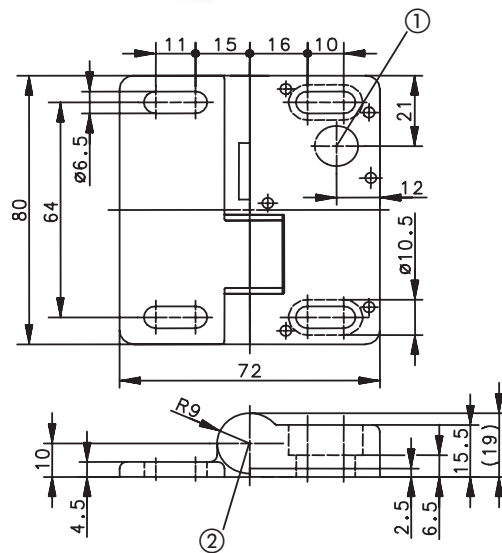
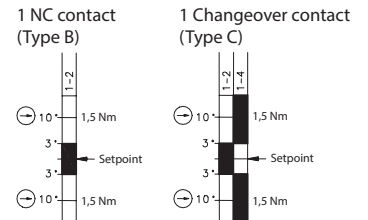
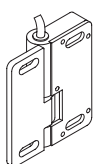

Illustration showing fixed pin and shearing bolt sheared off

- ① Position of connection variant 2, 5 and 6.
- ② Position of connection variant 1, 3 and 4.

### Connection variant 1



Cable, PVC

### Connection variant 2

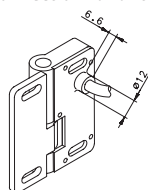

Cable, PVC

### Connection variant 3

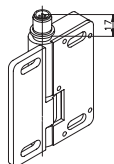

Connector M12 x 1, metal thread

### Connection variant 4

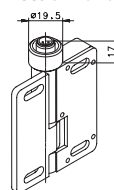

Connector M12 x 1, metal thread with anti-tamper facility

### Connection variant 5

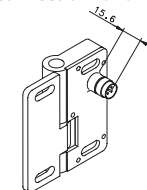

Connector M12 x 1

### Connection variant 6

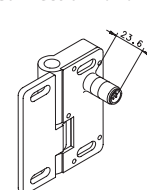



Connector M12 x 1

## Product selection

Article number	Designation	Switching contact	Max. switching voltage	Type of voltage	Connection variant		Required cable coupling / type	Remarks
					radial	axial		
6019261011	SHS-A1Z-KA 5	1 NC	230 V	AC/DC		Cable	1	BG approval
6019261014	SHS-A1Z-KR 5	1 NC	230 V	AC/DC	Cable		2	BG approval
6019261017	SHS-A1Z-SA-BG	1 NC	230 V	AC/DC		M12	4	A BG approval
6019261018	SHS-A1Z-SR-BG	1 NC	230 V	AC/DC	M12		6	A BG approval
6019261009	SHS-A1Z-SA	1 Changeover contact	230 V	AC/DC		M12	3	C
6019261010	SHS-A1Z-SR	1 Changeover contact	60 V	DC	M12		5	B
6019261015	SHS-A1Z-SA	1 Changeover contact	60 V	DC		M12	3	B
6019261016	SHS-A1Z-SR	1 Changeover contact	230 V	AC/DC	M12		6	C
6019291013	SHS-OZ							Blank hinge

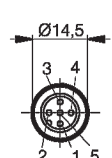
## Accessories

SHS Cable Type A					
Article number	Designation	Cable length	Connector type	Number of pins	Special feature
3251103234	AN-KAB.SH5 5M AC STRAIGHT	5 m	Straight	3	AC/DC BG version
3251103236	AN-KAB.SH5 5M AC ELBOW	5 m	Elbow	3	AC/DC BG version
Contact assignments, AC/DC versions					
 <p>1 = Green-yellow 2 = Black 3 = Blue</p>		Core insulation/sheathing material:		PVC (UL)/PVC (UL)	
		Moulding/contact carrier material:		PUR (UL)/PUR (UL)	
		Max. rated voltage:		300 V AC	
		Max. current carrying capacity:		3 A	
		Min./max. temperature range:		-25 °C/+70 °C	
		Cable configuration mm <sup>2</sup> :		3 x 0,5	
Protection class when assembled:		IP 67			
SHS Cable Type B					
Article number	Designation	Cable length	Connector type	Number of pins	Special feature
3251003221	AN-KAB.SH5 2M DC STRAIGHT	2 m	Straight	3	DC approval
3251003222	AN-KAB.SH5 5M DC STRAIGHT	5 m	Straight	3	DC approval
3251003223	AN-KAB.SH5 10M DC STRAIGHT	10 m	Straight	3	DC approval
3251003224	AN-KAB.SH5 2M DC ELBOW	2 m	Elbow	3	DC approval
3251003225	AN-KAB.SH5 5M DC ELBOW	5 m	Elbow	3	DC approval
3251003226	AN-KAB.SH5 10M DC ELBOW	10 m	Elbow	3	DC approval
Contact assignments, DC versions					
 <p>1 = Brown 2 = - 3 = Blue 4 = Black</p>		Core insulation/sheathing material:		PVC/PVC	
		Moulding/contact carrier material:		PUR/PUR	
		Max. rated voltage:		60 V AC/75 V DC	
		Max. current carrying capacity:		1,5 A	
		Min./max. temperature range:		-25 °C/+70 °C	
		Cable configuration mm <sup>2</sup> :		3 x 0,34	
Protection class when assembled:		IP 67			
SHS Cable Type C					
Article number	Designation	Cable length	Connector type	Number of pins	Special feature
3251004219	AN-KAB.SH5 5M AC STRAIGHT	5 m	Straight	4	AC/DC-approval
3251004220	AN-KAB.SH5 5M AC ELBOW	5 m	Elbow	4	AC/DC-approval
Contact assignments, AC/DC versions					
 <p>1 = Brown 2 = Black 3 = Blue 4 = Green-yellow</p>		Core insulation/sheathing material:		PVC/PVC	
		Moulding/contact carrier material:		PUR/Nylon 6.6	
		Max. rated voltage:		300 V AC	
		Max. current carrying capacity:		4,0 A	
		Min./max. temperature range:		-5 °C/+70 °C	
		Cable configuration mm <sup>2</sup> :		4 x 0,34	
Protection class when assembled:		IP 68			

## Technische Daten SHS

- Rated insulation voltage  $U_i$  250 V
- Rated operating voltage  $U_e$  230 V AC ; 60 V DC
- Conv. thermal current  $I_{the}$  3 A
- Utilization category / switching capacity:  
AC-15, 230 V / 1,5 A ; DC-13, 60 V / 0,5 A
- Mechanical switching frequency max.  $\leq$  1200/h
- Mechanical service life  $1 \times 10^6$  switching cycles
- B10d:  $2 \times 10^6$  million
- Ambient temperature -25 °C to +70 °C  
(connection cable installed)
- Protection class IP 67 in accordance with IEC/EN 60529
- Mechanical load:  
 $F_{R1}$  = max. 1000 N ;  $F_{R2}$  = 500 N ;  $F_A$  = 750 N