

Signalling Relays

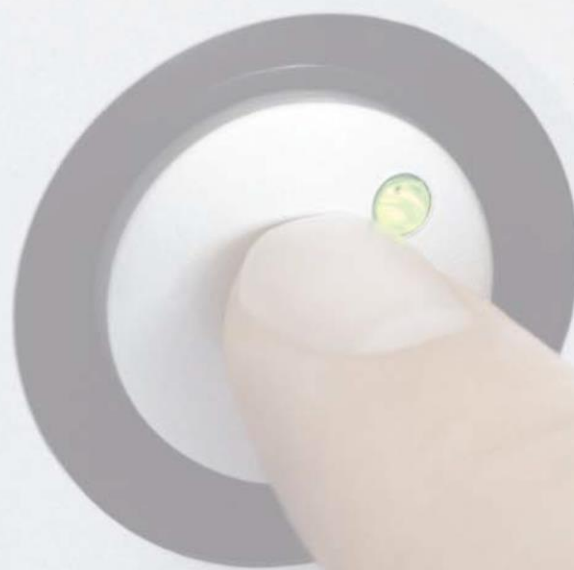

RA 70



POWER

Overview of device range

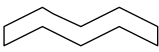
RA 70 Signalling Relays

Input quantities			
12 V AC ... 400 V AC		12 V DC ... 220 V DC	
Working current type	Closed-circuit type	Working current type	Closed-circuit type
Signal information			
Initial condition: white		Signalling condition: red	
		Acknowledge condition: black	
Contact systems			
2 changeover contacts	1 changeover contact & 1 passing contact	1 changeover contact & 1 make contact (NO) in middle position	1 make contact (NO) in middle position & 1 passing contact
			1 changeover contact operated directly & 1 changeover contact
			1 changeover contact operated directly & 1 passing contact
			1 changeover contact operated directly & 1 make contact (NO) in middle position

Product description and application

The RA 70 signalling relays are used to signal and monitor operating states, faults, errors, in power plants and generators, power distribution systems and in virtually all industrial plants.

They are used, for example, to display:

- Operating states in electrical installation parts and systems
- Exceeding of pressure, temperature, etc. limit values.
- Faults due to the activation of protective devices of transformers, motors, generators in power generation and distribution systems, etc.
- Power failures of control circuits

The signal information (e.g. error, fault, power failure, etc.) is saved until acknowledgement by manual operation of the drop indicator and until removal of the cause of the signal.

The contacts operated by the signalling relay in case of signal information can be used for optical and/or acoustic indication or to trigger further relays, e.g. to switch off faulty equipment.

If necessary, a passing contact enables the activation of an acknowledged circuit for central signalling of errors or other signal information.

Device configuration

The devices have a black moulded housing and a cap with inspection window for message display, which is removable for customised labelling. On request, customised labelling can also be carried out by the manufacturer. The manual operating button for the drop indicator is on the front of the housing.

All screw connections for electrical contacting are arranged on the baseplate.

The magnetic system is made of soft magnetic relay iron. It can be equipped with a single or a double coil. The hinged armature has a knife-edge bearing and the drop indicator is triggered by a mechanical latch and is reset by manual operation.

Two directly or indirectly operated contacts exist in the following variants:

- 2 changeover contacts
- 1 changeover contact and 1 passing contact
- 1 changeover contact and 1 make contact (NO) in middle position
- 1 make contact (NO) in middle position and 1 passing contact
- 1 changeover contact operated directly and 1 changeover contact
- 1 changeover contact operated directly and 1 passing (wiping) contact
- 1 changeover contact operated directly and 1 make contact (NO) in middle position

Depending on the information to be displayed, the drop indicator has the following colour:

- Initial condition: white viewing area
- Signalling condition: red M on white area
- Acknowledge condition: black M on white area

The device is intended for panel installation. A clamping frame or screw clamp fixing can be chosen as the fixing type. Alternatively, to panel installation, a design variant for top-hat mounting rail installation is also available.

Action



On triggering, the drop indicator changes from the rest position to the signalling position. This position is retained even when the cause of the signalling is removed.

On manual operation, if the cause of the signalling still exists the acknowledge position is occupied, if the cause of the signalling no longer exists the rest position is occupied.

If the cause of the signalling is removed in the acknowledge position the relay changes automatically to the rest position.

These relay functions can be implemented not only in the working current type but also in the closed-circuit type.

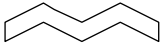
See following figure for function of the working current type and the closed-circuit type:

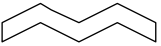
	Initial condition	Message	Acknowledged*	
			still present	removed
Working current	Magnetic system not energised	Magnetic system energised	Magnetic system energised	Magnetic system not energised
Closed-circuit current	Magnetic system energised	Magnetic system not energised	Magnetic system not energised	Magnetic system energised
Visual sign	 white	 red	 black	 white
Contacts	see representation of circuit diagram in initial position	see representation of circuit diagram in signalling position	see representation of circuit diagram in acknowledge position	see representation of circuit diagram in initial position

*In the special version of the RA 70 **without acknowledge position** the "Acknowledged" column is omitted and in the circuit diagrams the contact "acknowledge position" is omitted.

Connection

The connection, 1 to 2 Cu conductors 0.5 mm² to 2.5 mm², is made at the screw terminals attached to the back of the signalling relay. The connection side has degree of protection IP 20 with terminal cover and degree of protection IP 00 without cover.

Additional elements, which are screwed below the screw terminals, can be used to also implement 4.8 or 6.3 tab connections or soldered connections with degree of protection IP 00 on the connection side.

The signalling relays can also be executed with a flyback diode GP02-40 (4 kV reverse voltage), arranged between terminals 1 (cathode) and 2 (anode).

Depending on their specific relay contact wiring, the user may have to provide measures to meet the requirements of the EMC law.

Protective circuits

Protective circuits are used to protect against breaking voltage peaks, caused by the switching of inductances and to reduce the contact load. Among other things, they prevent malfunctioning or irreparable damage to electronics and insulation caused by overvoltage, reduce radio interference, material migration and contact wear (erosion). The protective circuit should be attached directly at the fault location.

The RA70 signalling relay can be used with the following protective circuits:

• Diode protective circuit

Advantages: - no overvoltage (only approx. 0.7 V)
- low costs
- for DC only

Disadvantages: - causes dropout delay at the relay
- not protected against polarity reversal

• Varistor protective circuit

Advantages: - for DC and AC
- only low dropout times at the relay
- low costs
- protected against polarity reversal

Disadvantages: - relatively high remaining overvoltage

• RC protective circuit

Advantages: - for DC and AC
- low overvoltage
- only low dropout times at the relay
- protected against polarity reversal

Disadvantages: - relatively high making current peaks
- not for small voltages
- increased dropout times at the relay
- R and C must be optimised for L_{Coil}

On period

Signalling relays with single coil are suitable for actuation of the coil in continuous operation.

For signalling relays with double coil, continuous operation (e.g. closed-circuit type) is only permitted with exclusive actuation of one of the two coil inputs.

Actuation of both coil inputs is only permitted in pulse mode as shown in the following load diagram:

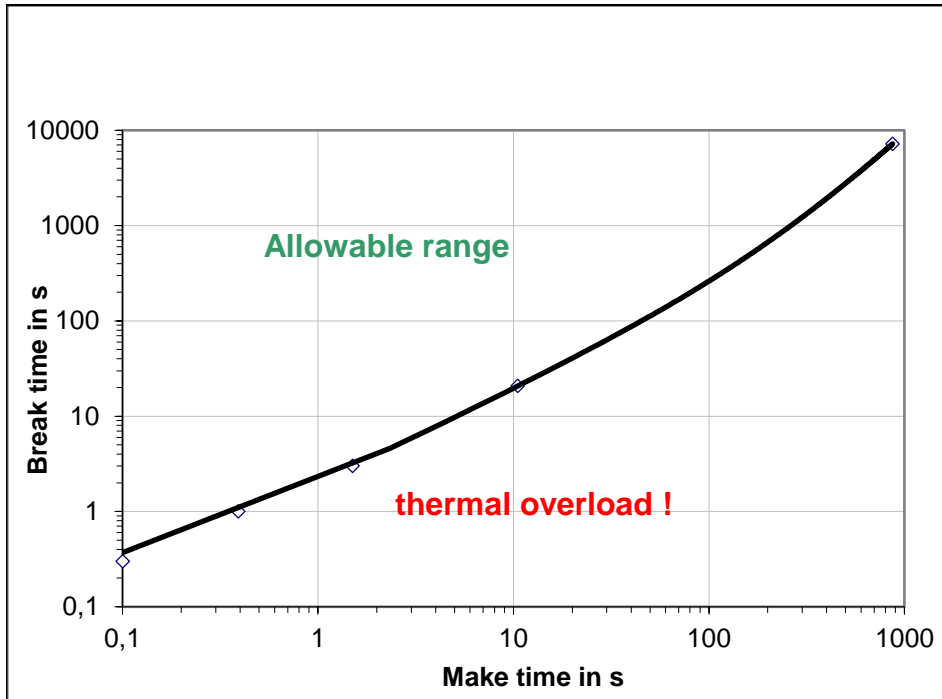

Note on use of double coil relays with 1 or 2 DC inputs

If the relay operates with simultaneous energising of both coils (AND operation), the polarity of the connected control circuits must be noted.

If the two coils have opposite polarity, in case of simultaneous energising, opposite magnetic fields develop which compensate for each other. The relay then operates solely on activation of a coil group. (XOR operation).

Conformity with standards

The data for the RA 70 signalling relays, including accessories, is based on the following national and international standards:

DIN VDE 0435-110 / VDE Part 110: 1989-04

Electrical relays, terms and definitions

DIN EN 60810-1 / VDE 0435 Part 201: 1999-04

Electromechanical non-specified time all-or-nothing relays;

Part 1: General requirements

DIN EN 60810-5 / VDE 0435 Part 140: 1999-04

Electromechanical non-specified time all-or-nothing relays;

Part 5: Insulation coordination

DIN EN 60255-23 / VDE 0435 Part 120: 1997-03

Part 23: Electrical relays; Contact performance

DIN EN 60529 / VDE 0470 Part 1: 2000-12

Degrees of protection provided by enclosures (IP code)

DIN EN 60999-1 / VDE 0609 Part 1: 2000-12

Connecting devices. Electrical copper conductors. Safety requirements for screw-type and screwless-type clamping units

CE conformity

The signalling relays of the RA 70 type series comply with the European directives

- 73/23/EEC "Low Voltage Directive" of 19/02/1973 and
- 89/392/EEC "EMC Directive" of 03/05/1989

including the changes if using the terminal cover (degree of protection IP 20) apart from the following deviation from the EN 61810-1: 1999.04 standard:

The company logo and type designation are not legible in the installed condition for normal operation.

The CE marking is attached to the printing on the side of the relay or on the packaging.

Technical characteristics

Input characteristics:

Nominal voltages:	12 V to 400 V AC, 12 V to 220 V DC (see list of order numbers)
Nominal frequency:	0 Hz, 50 Hz, 60 Hz
All. nominal frequency tolerance:	$\pm 6\%$
Working range of the coil voltage:	Class 1 to EN 61810-1: 04.1999
Operate voltage:	$\leq 0.8 \times U_N$
Max. operating voltage:	$1.1 \times U_N$
Duty:	Continuous duty
Operating system overload capability:	$2 U_N$ AC or DC, 1 min (in acc. with power supply utility requirement)
Mode:	Working current or closed-circuit current
Minimum operating time:	≥ 30 ms at U_N
Release voltage:	$\geq 10\%$ of U_N for AC $\geq 5\%$ of U_N for DC
Rated power:	≤ 3.0 VA, $\cos \varphi = 0.32$ for AC (relay armature in the initial position) ≤ 3.0 VA, $\cos \varphi = 0.62$ for AC (relay armature picked up) ≤ 2.5 W with DC

Output characteristics:

Relay contact variants:	2 changeover contacts 1 changeover contact and 1 passing (wiping) contact 1 changeover contact and 1 make contact (NO) in middle position 1 make contact (NO) in middle position and 1 passing contact 1 changeover contact operated directly and 1 changeover contact 1 changeover contact operated directly and 1 passing contact 1 changeover contact operated directly and 1 make contact (NO) in middle position
Contact application classes:	1, 2, 3 in acc. with EN 60255-23 / 03.97
Switching voltage max.:	≤ 250 V AC/DC
Contact type:	Single contact
Contact material:	
- Type:	Hard silver - AgCu4
- Main use ranges:	24 V ... 250 V; 5 mA ... 10 A, ≥ 1 W
- Contact resistances:	≈ 40 m Ω when new
- Main areas of use:	universal use for moderate AC and DC loads
Max. making capacity:	10 A
Limiting continuous current:	5 A
Max. all. continuous current:	6 A
Max. breaking capacity:	10 A $\cos \varphi = 1.0$ 230 V AC 6 A $\cos \varphi = 0.4$ 230 V AC 0.6 A $\tau = 0$ ms 220 V DC 0.2 A $\tau = 40$ ms 220 V DC
Min. switching capacity:	24 V, 50 mA
Max. frequency of operation:	≤ 600 cycles per hour
Electrical endurance:	$\geq 1 \times 10^5$ cycles at max. breaking capacity
Interval time of the pulse contact element:	≥ 40 ms

Characteristic use values:

Ambient temperature:	- 10°C to 50°C for close packed layout - 10°C to 55°C for individual layout (spacing ≥ 60 mm)
Rated impulse voltage:	4.0 kV, voltage waveform 1.2/50 μ s to EN 61810-5: 04.1999
Rated insulation alternating voltage:	2.0 kV if $U_N \leq 250$ V 2.5 kV if $U_N = 400$ V
Pollution degree:	2 to EN 61810-5: 04.1999 for $U_N = 400$ V AC 3 to EN 61810-5: 04.1999 for $U_N \leq 250$ V AC
Clearances:	≥ 3 mm to EN 61810-5: 04.1999
Creepage distances:	≥ 4 mm to EN 61810-5: 04.1999
Installation altitude:	≤ 2000 m above sea level
HF interference immunity (1 MHz):	Class III to IEC 255 Part 22-1 / 05.91 1.0 kV mating contact voltage (transverse voltage) 2.5 kV common-mode voltage (longitudinal voltage)

Ambient conditions, environmental test method:

Low temperature:	EN 60068 - 2 - 1, Issued 03.1995; Test Ab - 10°C -Function - 40°C -Strength/transport/storage
High temperature:	EN 60068 - 2 - 1, Issued 03.1995; Test Bb 50°C -; 55°C; 70°C
Damp heat, constant:	EN 60068 - 2 - 3, Issued 12.1986; Test Ca (40°C)
Damp heat, cyclic:	EN 60068 - 2 - 30, Issued 09.1996; Test Db40 (25°C / 40°C)
Corrosive atmosphere:	EN 60068 - 2 - 42 / 43, Issued 08.1985 08.1985; Test Ki (Kc+Kd) (SO ₂ 10 mg/m ³ + H ₂ S 0.75 mg/m ³ ; 40°C)
Salt mist:	EN 60068 - 2 - 11, Issued 08.1985; Test Ka (30 g ± 1 g NaCl / dm ³ H ₂ O)
Bump:	EN 60068 - 2 - 29, Issued 03.1995; Test Eb Strength: 150 m / s ² ; 6 ms Strength: 100 m / s ² ; 16 ms Function: 50 m / s ² ; 16 ms
Vibration, sinusoidal:	EN 60068 - 2 - 6, Issued 05.1995; Test Fc Strength: Frequency range 10...500 Hz Amplitude 0.15 mm, ≤ 60 Hz Crossover frequency 60 Hz Acceleration 20 ms ⁻² , > 60 Hz Function: 10...500 Hz 0.075 mm, ≤ 60 Hz Crossover frequency 60 Hz Acceleration 10 ms ⁻² , > 60 Hz Function, strength: Frequency range 5...80 Hz 0.55 mm, ≤ 30 Hz Hz Crossover frequency 30 Hz Acceleration 20 ms ⁻² , > 30 Hz

Installation and connection conditions:

Operating position:	Front face vertical to horizontal, facing upwards up to approx. 5 m at a viewing angle of 90° ± 20° relative to the front face closed panel installation housing,
Detectability of the visual display:	transparent inspection window
Relay enclosure:	to EN 60529-1: 2000-12
Degree of protection	IP 40
- Relay enclosure:	IP 00, with additional terminal cover IP 20
- Terminals:	Screw terminal
Connections:	Tab connection 4.8 or 6.3 (DIN 46244) or soldered connection via additional elements, which are ordered and delivered separately and must be screwed on.
Connectable connection conductor:	1 or 2 × 0.5 mm ² up to 2.5 mm ² Cu single and multi-wire 1 or 2 × 1.0 mm ² up to 2.5 mm ² Cu fine wire
Fixing:	Clamping frame, screw clamp fixing, top-hat rail adapter
- Single coil	screw clamp fixing only
- Double coil	
Front dimensions:	60 mm × 60 mm
Panel cutout	54.5 ^{+0.5} mm × 54.5 ^{+0.5} mm
Weight	approx. 0.3 kg
Dimensioned drawing	Rs 805 275
Operating instructions:	Rs 808 274

General information:

Production quality:	The RA 70 signalling relays are produced according to a quality management system in compliance with the EN ISO 9004 requirements and are documented in accordance with EN ISO 9001.
Useful life:	Expected value ≥ 20 years, provided the electrical and/or mechanical life are not exceeded beforehand.

Transport and storage condition:

Temperature range:	- 50 °C to 70 °C
Storage location:	enclosed and ventilated rooms

Dimensions / Installation / Labelling

The relay is installed in panel cutouts $54.5^{+0.5}$ mm \times $54.5^{+0.5}$ mm. The panel can be 1 ... 10 mm thick. The mounting position of the signalling relay (front face) can be vertical to horizontal facing upwards.

The fixing in the device type with clamping frame is made using the spring elements supplied. The clamping frame is pushed onto the housing from behind and latches into the grooves of the housing. The clamping frame fixing is designed so that the signalling relays can be mounted on the front, horizontally and vertically, close next to each other.

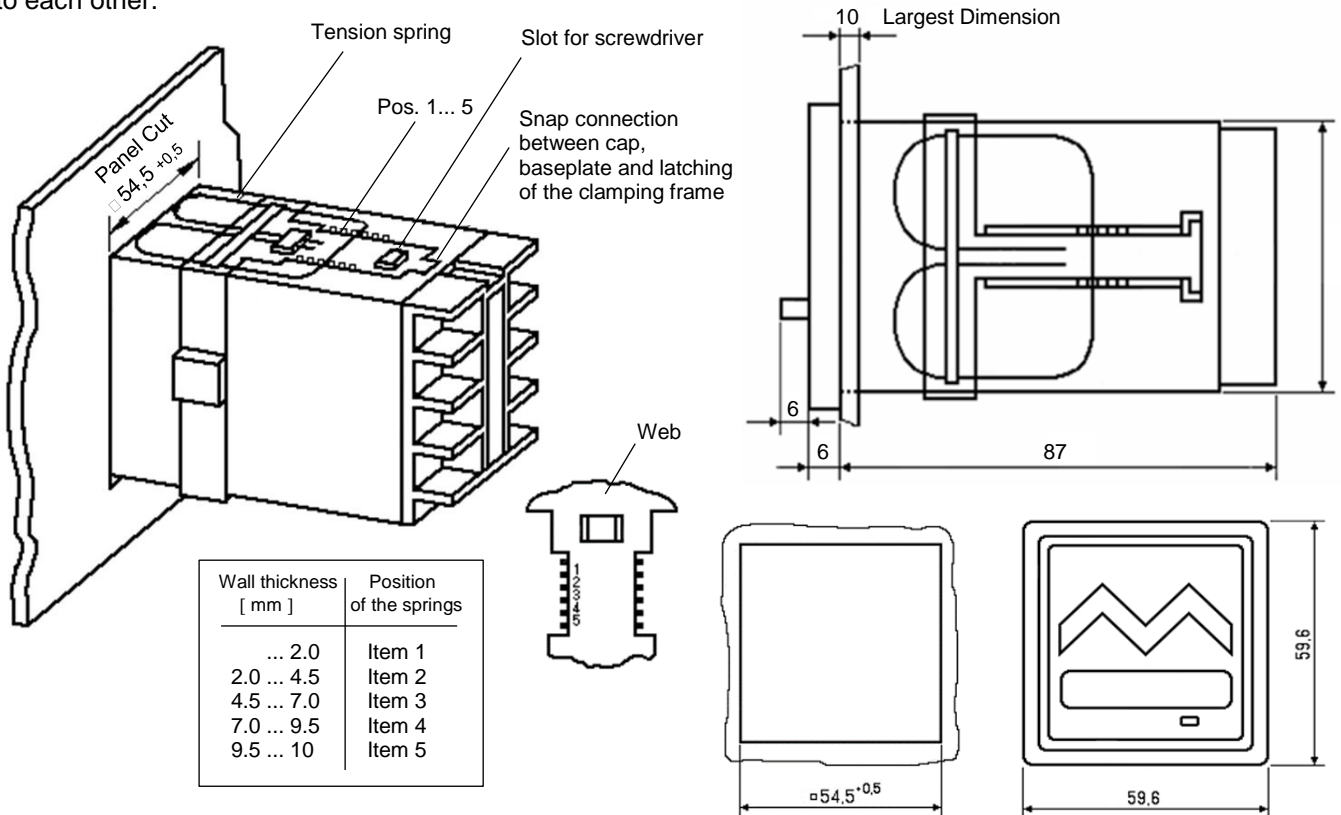

Clamping frame installation diagram

2 to 4 signalling relays can also be installed in a 4-slot panel housing to DIN 43 700. The size of the front frame is 144 mm \times 144 mm with a panel cutout of 138 mm \times 138 mm

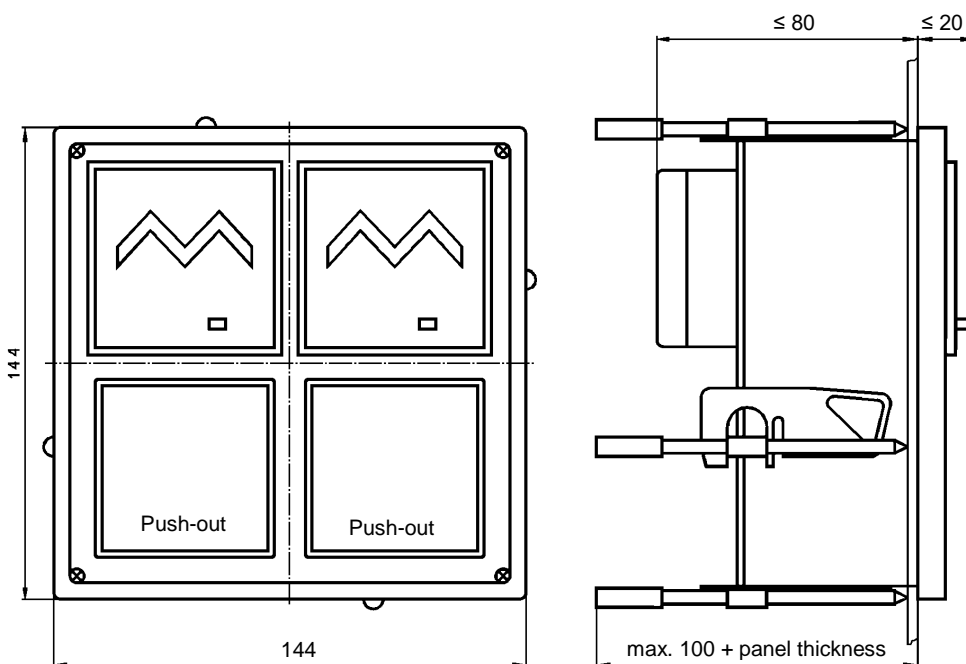

4-slot panel housing for 2 to 4 signalling relays type RA 70

In the device type with screw fixing, two screw clamps are enclosed with the device, which must be inserted in the four (two each device side) fixing openings in the sides of the devices in order to install the device.

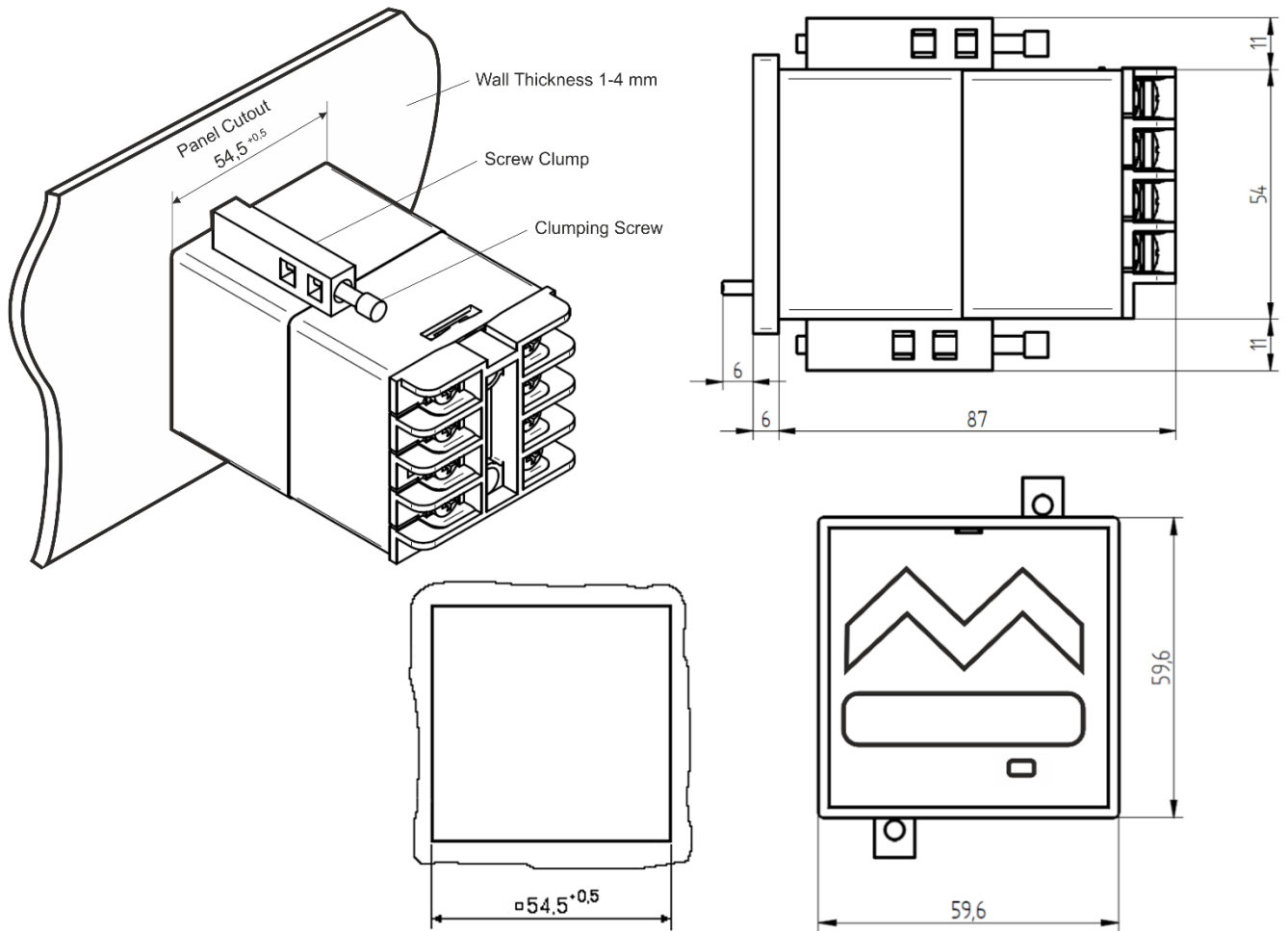

Screw clamp fixing installation diagram

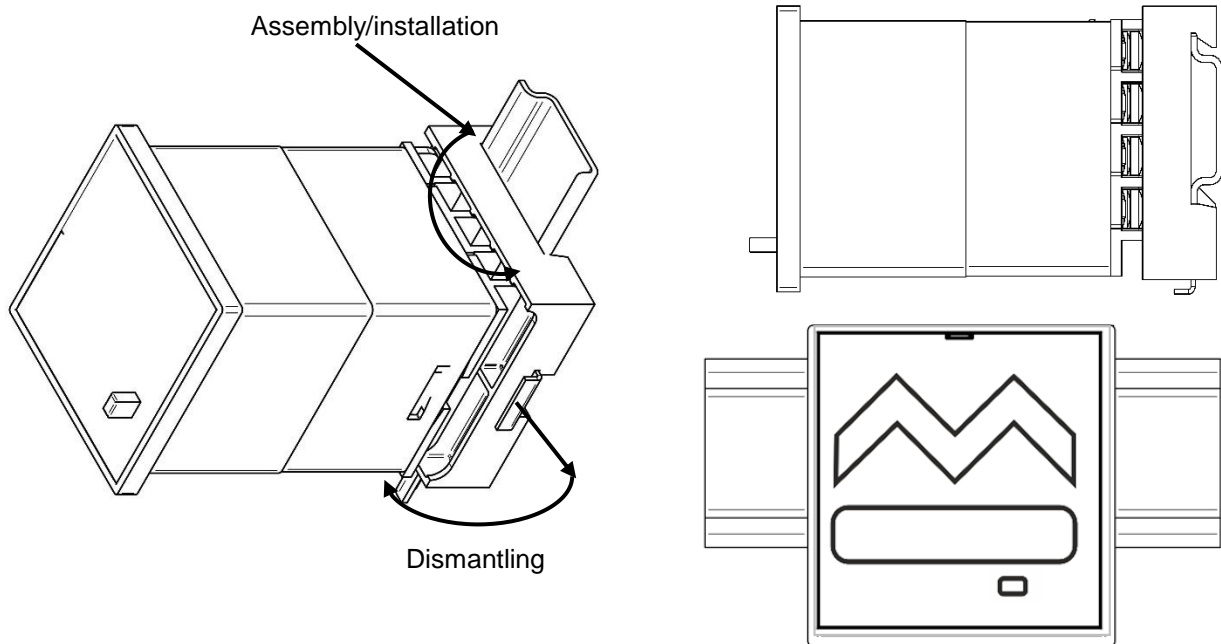

Top-hat mounting rail adapter installation diagram

Terminal

Connection 7 not present in type with pulse contact element

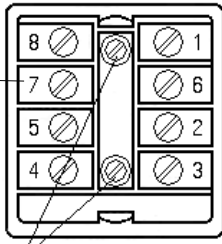

do not undo

Relay with single coil

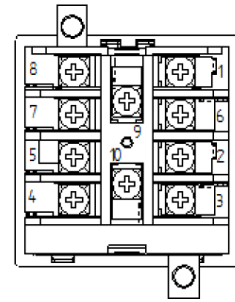

Relay with double coil

Circuit diagrams

Circuit diagrams for alternating voltage relays

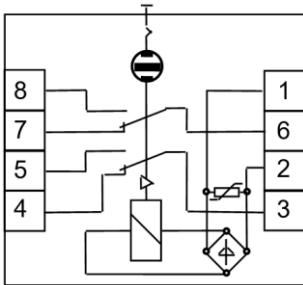

Version with 2 changeover contacts

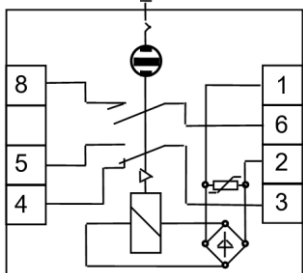

Version with 1 changeover contact and 1 passing contact

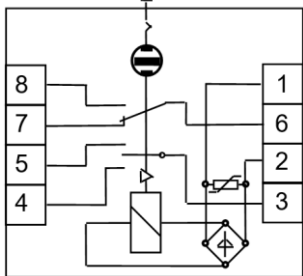

Version with 1 changeover contact and 1 make contact (NO) in middle position

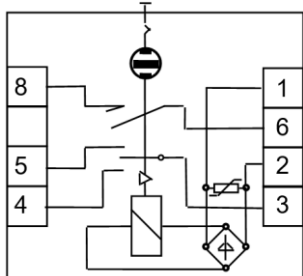

Version with 1 make contact (NO) in middle position and 1 passing contact

Initial position
 Signalling position
 Acknowledge position

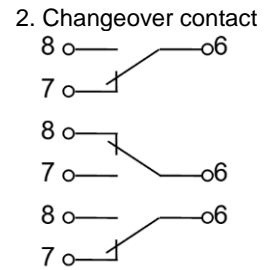
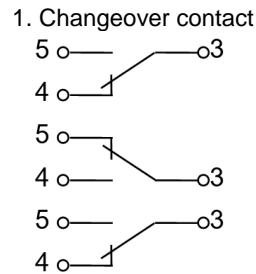

Initial position
 Signalling position
 Acknowledge position

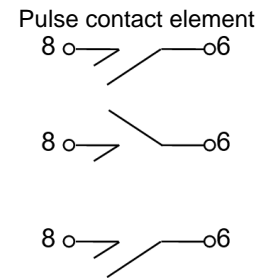
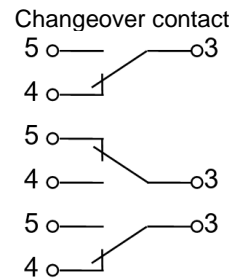

Initial position
 Signalling position
 Acknowledge position

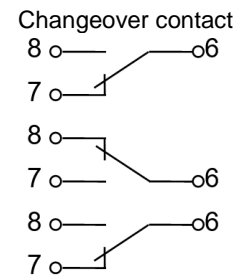
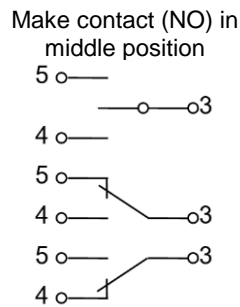

Initial position
 Signalling position
 Acknowledge position

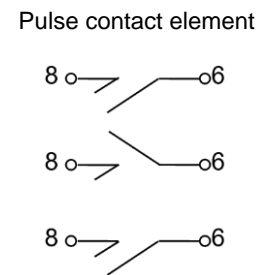
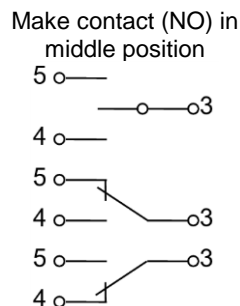

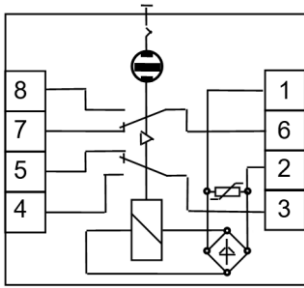

Version with 1 changeover contact operated directly and 1 changeover contact

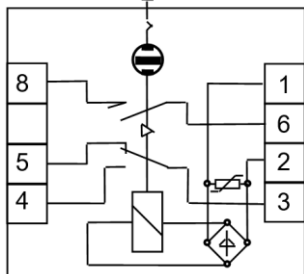

Version with 1 changeover contact operated directly and 1 passing contact

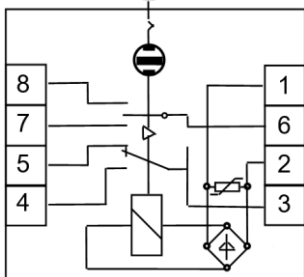

Version with 1 changeover contact operated directly and 1 make contact (NO) in middle position

Changeover contact operated directly

Operating system dropped out
Operating system picked up

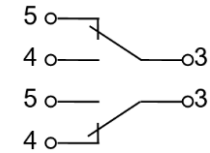

Initial position

Signalling position

Acknowledge position

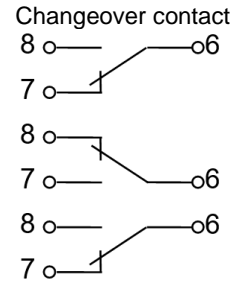

Changeover contact operated directly

Operating system dropped out
Operating system picked up

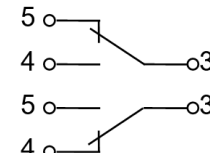

Initial position

Signalling position

Acknowledge position

Pulse contact element

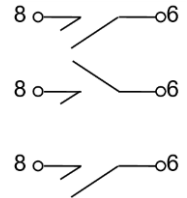

Changeover contact operated directly

Operating system dropped out
Operating system picked up

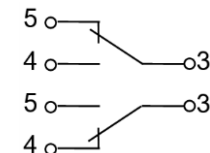

Initial position

Signalling position

Acknowledge position

Make contact (NO) in middle position

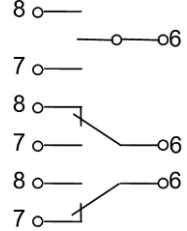

Circuit diagrams for direct voltage relays

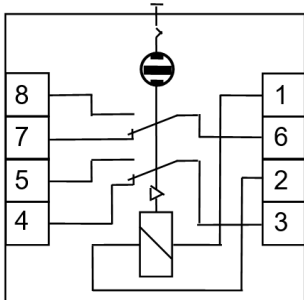

Version with 2 changeover contacts

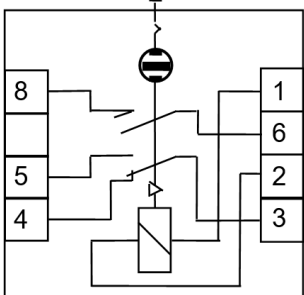

Version with 1 changeover contact and 1 passing contact

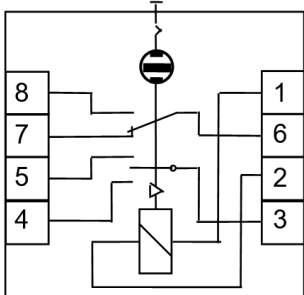

Version with 1 changeover contact and 1 make contact (NO) in middle position

Initial position
Signalling position
Acknowledge position

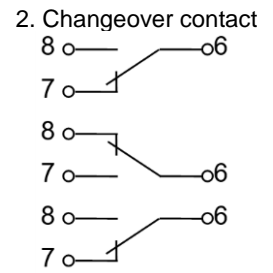
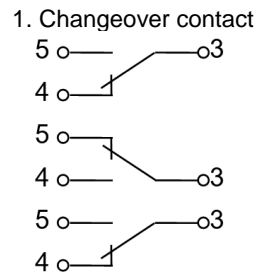

Initial position
Signalling position
Acknowledge position

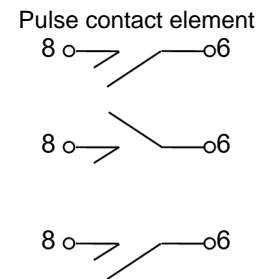
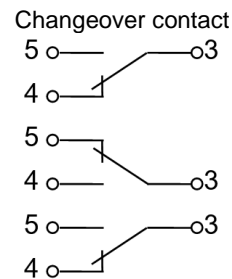

Initial position
Signalling position
Acknowledge position

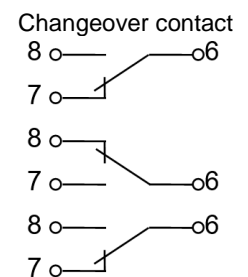
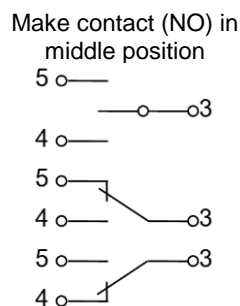

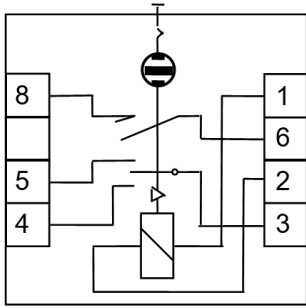

Initial position

Signalling position

Acknowledge position

Make contact (NO) in middle position

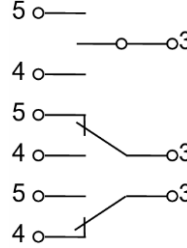

Pulse contact element

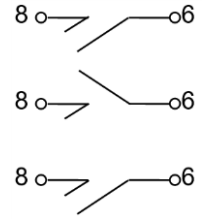

Version with 1 make contact (NO) in middle position and 1 passing contact

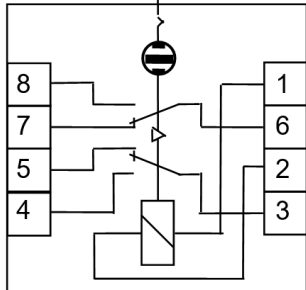

Operating system dropped out

Operating system picked up

Changeover contact operated directly

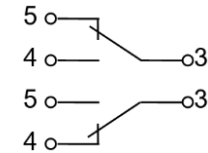

Initial position

Signalling position

Acknowledge position

Changeover contact

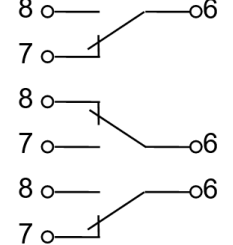

Version with 1 changeover contact operated directly and 1 changeover contact

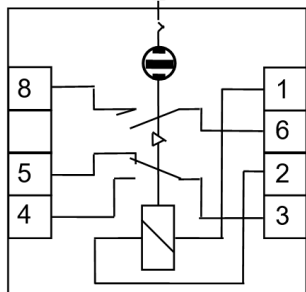

Operating system dropped out

Operating system picked up

Changeover contact operated directly

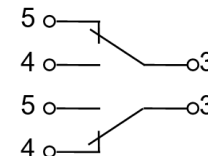

Initial position

Signalling position

Acknowledge position

Pulse contact element

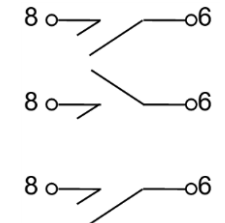

Version with 1 changeover contact operated directly and 1 make contact (NO) in middle position

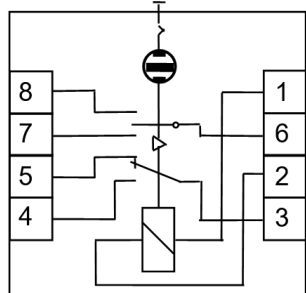

Operating system dropped out

Operating system picked up

Changeover contact operated directly

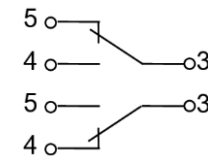

Initial position

Signalling position

Acknowledge position

Make contact (NO) in middle position

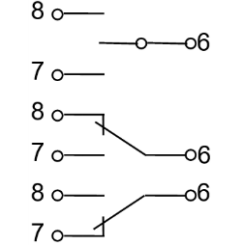

Version with 1 changeover contact operated directly and 1 make contact (NO) in middle position

All DC versions can be equipped as a special type with flyback diode on the coil:

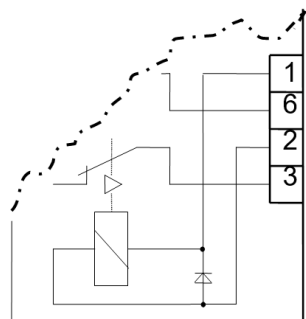

Circuit diagrams for double coil relays

Execution example: Contact system with 2 changeover contacts

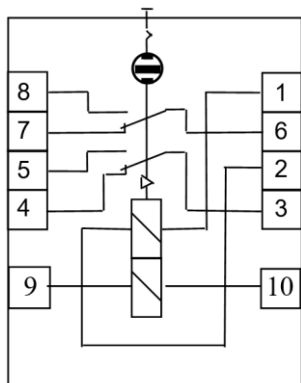

**U1 DC at coil 1 (connection 1 and 2)
U2 DC at coil 2 (connection 9 and 10)**

Initial position
Signalling position
Acknowledge position

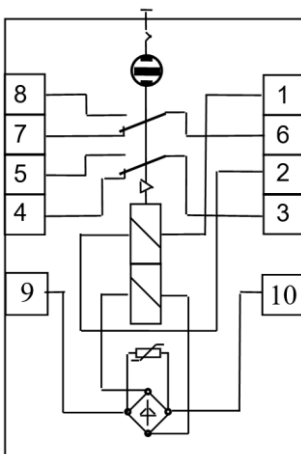
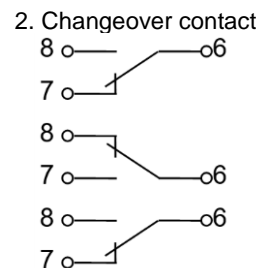
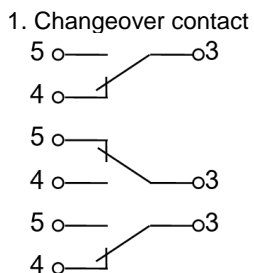

**U1 DC at coil 1 (connection 1 and 2)
U2 AC at coil 2 (connection 9 and 10)**

Initial position
Signalling position
Acknowledge position

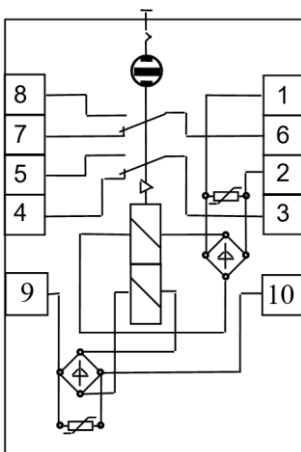
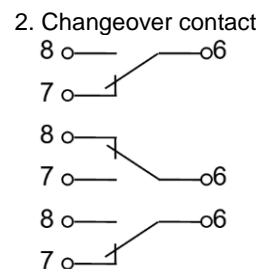
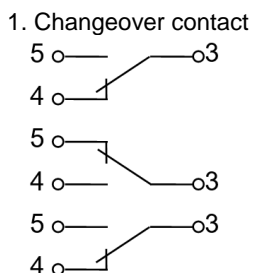

**U1 AC at coil 1 (connection 1 and 2)
U2 AC at coil 2 (connection 9 and 10)**

Initial position
Signalling position
Acknowledge position

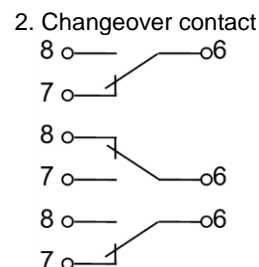
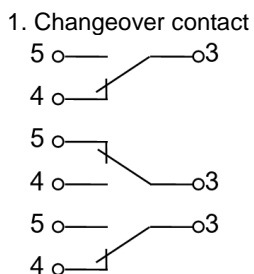

The RA70 signalling relays equipped with double coils are available with all contact system combinations of the single coil alternating and direct voltage relays. Refer to the respective devices for the corresponding contact diagrams.

Type code, RA70 with single coil

Product type		<u>1732</u>	<u>X</u>	<u>XX</u>	<u>X</u>	<u>X</u>	<u>XXX</u>
RA70							
Fixing							
Spring fixing	8						
Screw fixing	3						
Top-hat rail mounting	9						
Direct voltage							
Working current type							
60V	84						
67V	80						
110V	86						
120V	60						
220V	88						
Special voltages	82						
Closed-circuit type							
60V	85						
67V	81						
110V	87						
120V	61						
220V	89						
Special voltages	83						
Alternating voltage							
Working current type							
24V	92						
110V	70						
230V	94						
400V	96						
Special voltages	90						
Closed-circuit type							
24V	93						
110V	71						
230V	95						
400V	97						
Special voltages	91						
Acknowledgement							
with acknowledge position (normal type*)		0					
with acknowledge position with diode GP02-40		1					
with indicator		3					
with indicator with diode GP02-40		4					
without acknowledge position		8					
without acknowledge position with diode GP02-40		9					
Contacts							
2 changeover contacts		0					
1 changeover contact and 1 passing contact		1					
1 changeover contact and 1 make contact (NO) in middle position		2					
1 make contact (NO) in middle position and 1 passing contact		3					
1 changeover contact operated directly and 1 changeover contact		4					
1 changeover contact operated directly and 1 passing contact		5					
1 changeover contact operated directly and 1 make contact (NO) in middle position		6					
Special voltages							
Normal type	0						
Special voltage	001-999						

* Relays for use on ocean-going ships on request

Type code, RA70 with double coil

Product type		<u>1732</u>	<u>4</u>	<u>X</u>	<u>X</u>	<u>XXX</u>
RA70	----- ----- ----- ----- ----- -----					
Mode						
Double coil	----- ----- ----- ----- ----- -----					
Acknowledgement						
with acknowledge position (normal type)	0	----- ----- ----- ----- ----- -----				
with acknowledge position with diode GP02-40	1	----- ----- ----- ----- ----- -----				
with indicator	3	----- ----- ----- ----- ----- -----				
with indicator with diode GP02-40	4	----- ----- ----- ----- ----- -----				
without acknowledge position	8	----- ----- ----- ----- ----- -----				
without acknowledge position with diode GP02-40	9	----- ----- ----- ----- ----- -----				
Contacts						
2 changeover contacts	0	----- ----- ----- ----- ----- -----				
1 changeover contact and 1 passing contact	1	----- ----- ----- ----- ----- -----				
1 changeover contact and 1 make contact (NO) in middle position	2	----- ----- ----- ----- ----- -----				
1 make contact (NO) in middle position and 1 passing contact	3	----- ----- ----- ----- ----- -----				
1 changeover contact operated directly and 1 changeover contact	4	----- ----- ----- ----- ----- -----				
1 changeover contact operated directly and 1 passing contact	5	----- ----- ----- ----- ----- -----				
1 changeover contact operated directly and 1 make contact (NO) in middle position	6	----- ----- ----- ----- ----- -----				
Coil voltage						
Working current type	000 - 499	----- ----- ----- ----- ----- -----				
Closed-circuit type	500 - 999	----- ----- ----- ----- ----- -----				

Note: The version of the RA70 device with double coil is only available with screw clamp fixing.

List of accessories order numbers

Terminal cover for degree of protection IP 20	Pl. No. 1. 732 848 000
Tab terminal 4.8 to DIN 46244	Pl. No. 1. 732 899 000
Tab terminal 6.3 to DIN 46244	Pl. No. 1. 732 899 001
Frame for panel cutout 58 mm × 58 mm *	Pl. No. 1. 732 898 000
4-slot panel housing for 2 to 4 signalling relays type RA 70	Pl. No. 1. 732 846 000

* For replacement needs when replacing RA 6 and RA 7 signalling relays (panel cutout 55[□]) with the RA 70 signalling relay