

› Monitoring Relays

Phase Control Relays

Voltage (under and over) between phases and neutral

- › H3US and M3US relays control, on 3-phase networks: overvoltage between phases, undervoltage between phases, phase failure detection
- › The H3USN relay controls, on 3-phase networks: overvoltage between phases and neutral, undervoltage between phases and neutral, loss of neutral, Phase failure detection
- › True RMS measurement
- › LED status indication

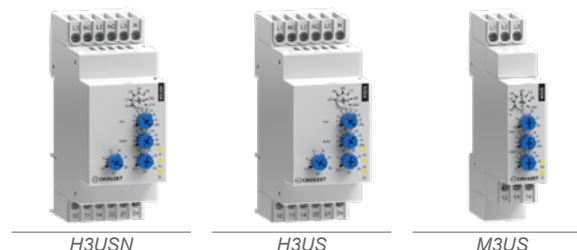

Selection guide					
Type	Function	Measuring range	Output	Power Supply	Part-Numbers
H3USN	Voltage (over and under voltage between phases monitoring) / Phase failure Detection	96 → 332 V \sim	2 x 5 A (changeover)	120 → 277 V \sim	84873221
H3US	Voltage (over and under voltage between phases monitoring) / Phase failure Detection	194 → 528 V \sim	2 x 6 A (changeover)	220 → 480 V \sim	84873220
M3US		183 → 528 V \sim	1 x 8 A (changeover)	208 → 480 V \sim	84873222

	H3USN	H3US	M3US
Timing			
Delay on threshold crossing (Tt)	0.3 → 30 s (0, +10 %)		
Repetition accuracy with constant parameters (according to IEC/EN 60255-1)	± 3 %		
Power ON delay	≤ 650 ms		
Reset time max	1500 ms		
Alarm on delay time max	200 ms		
Response time on appearance of a fault (Tr)			
Supply			
Voltage type for actuating	AC		
Rated control supply voltage Un at AC	3 x 120 → 3 x 277 V	3 x 220 → 3 x 480 V	3 x 208 → 3 x 480 V
AC supply voltage frequency 50/60HZ	± 10 %		
Voltage supply tolerance	-20 % / 20 %	-12 % / + 10 %	
Operating range	96 → 332 V \sim	194 → 528 V \sim	183 → 528 V \sim
Polarity with DC voltage	No		
Galvanic isolation of power supply/Input circuit	No		
Galvanic isolation of power supply/Output circuit	Yes		
Galvanic isolation of Input circuit/Output circuit	Yes		
Immunity from micro power cuts: typical	20 ms		
Maximum Power consumption at Un	4 VA @ 400 V \sim , 50 Hz	14 VA @ 400 V \sim , 50 Hz	10 VA @ 400 V \sim , 50 Hz

	H3USN	H3US	M3US
Insulation			
Rated Insulation voltage (according to IEC/EN 60664-1)	400 V		
Insulation coordination (according to IEC/EN 60664-1)	Overvoltage category III; pollution degree 3		
Insulation resistance supply and Output circuit (according to IEC/EN 60664-1 and IEC/EN 60255-27)	> 500 MΩ (500 V _{DC})		
Insulation resistance Input circuit and Output circuit (according to IEC/EN 60664-1 and IEC/EN 60255-27)	> 500 MΩ (500 V _{DC})		
Dielectric strength (according to IEC/EN 60664-1 and IEC/EN 60255-27)	2 kV / 1min / 1mA / 50Hz		
Impulse voltage (according to IEC/EN 60664-1 and IEC/EN 60255-27)	4 kV wave 1.2 / 50 μs		
Input and measuring specifications			
Measurement range	96 → 332 V _~	194 → 528 V _~	183 → 528 V _~
Display accuracy (according to IEC/EN 60255-1)	± 3 % of the displayed value		
Measuring error with drift temperature	0.05 %/°C		
Measuring error with drift voltage	< 1 % across the whole range		
Repetition accuracy with constant parameters (according to IEC/EN 60255-1)	± 0.5 %		
Voltage threshold adjustment	Undervoltage -2 → -20 % of selected Un Overvoltage 2 → 20 % of selected Un	Undervoltage -2 → -20 % of selected Un (-2 → -17 % across the 3 x 220 V range) Overvoltage 2 → 20 % of selected Un (+2 → +10 % across the 3 x 480 V _~ range)	Undervoltage -2 → -20 % of selected Un (-2 → -12 % across the 3 x 208 V range) (-2 → -17 % across the 3 x 220 V range) Overvoltage 2 → 20 % of selected Un (+2 → +10 % across the 3 x 480 V _~ range)
Frequency of measured signal	50 → 60 Hz ± 10 %		
Max. measuring cycle time	150 ms / True RMS measurement		
Voltage threshold hysteresis	2 % of fixed Un		
Selection of phase-phase nominal voltage Un	120-127-220-230-240- 260-277 V _~	220-380-400-415-440- 480 V _~	208-220-380-400-415- 440-480 V _~
Guaranteed phase failure detection threshold	N/A		
Asymmetry threshold hysteresis	N/A		
Asymmetry threshold adjustment	N/A		
Maximum regeneration (phase failure)	N/A		
Output specifications			
Maximum switching power (resistive)	1250 VA	1500 VA	2000 VA
Maximum rate (at max switching power)	360 operations/hour at full load		
Maximum breaking current	▪ 5 AAC 250 V _~ resistive ▪ 5 ADC 30 V _{DC} resistive	▪ 6 AAC 250 V _~ resistive ▪ 6 ADC 30 V _{DC} resistive	▪ 8 AAC 250 V _~ resistive ▪ 5 ADC 30 V _{DC} resistive
Minimum breaking current	10 mA / 5 V _{DC}		
Operating categories (according to IEC/EN 60947-5-1 and IEC/EN 60947-5-2)	AC 12, AC 13, AC 14, AC 15, DC 12, DC 13, DC 14		
Nominal rating	5 A	6 A	8 A
Voltage breaking capacity (according to IEC/EN 60255-1)	▪ 250 V _~ / 5 AAC resistive ▪ 30 V _{DC} / 5 A resistive	▪ 300 V _~ / 5 AAC resistive ▪ 250 V _{DC} / 0.2 A resistive	▪ 250 V _~ / 8 AAC resistive ▪ 300 V _{DC} / 0.2 A resistive
Electrical life (operations)	5 x 10 ⁴	3 x 10 ⁴	5 x 10 ⁴
Mechanical life (operations)	5 x 10 ⁶	1 x 10 ⁷	
1 or 2 changeover relays, AgNi (cadmium-free)	2 C/O		1 C/O

	H3USN	H3US	M3US
Functions			
Phase Failure detection	True	True	
Phase sequence detection	False		
Asymmetry	False		
Overvoltage between phases monitoring	True		
Undervoltage between phases monitoring	True		
Under/overvoltage with independent settings	False		
Undervoltage	False		
Overvoltage	False		
Loss of neutral	True	False	
General characteristics			
Temperature limits use (°C) (according to IEC/EN 60068-2)	-20 → +50		
Temperature limits stored (°C) (according to IEC/EN 60068-2)	-40 → +70		
MTBF in hours (according to IEC/TR 62380)	1326372.178	1149222.45	1598784.3
MTTF (according to IEC/TR 62380)	150 years	130 years	180 years
Led status indicator	<ul style="list-style-type: none"> ▪ Un: Green LED (power on) ▪ R1: Yellow LED (relay status ON) ▪ OFF LED (loss of neutral or total phase failure or undervoltage fault) ▪ R2: Yellow LED (relay status ON) ▪ OFF LED (loss of neutral or total phase failure or overvoltage fault) ▪ ALL LEDs blink when changing the measurement range 	<ul style="list-style-type: none"> ▪ Un: Green LED (power on) ▪ R1: Yellow LED (relay status ON) ▪ Flashes during the upper threshold crossing delay ▪ R2: Yellow LED (relay status ON) ▪ Flashes during the lower threshold crossing delay ▪ R1&R2: OFF LED (total phase failure fault) ▪ ALL LEDs blink when changing the measurement range 	<ul style="list-style-type: none"> ▪ Un: Green LED (power on) ▪ R: Yellow LED (relay status ON) ▪ Flashes during the threshold crossing delay ▪ ALL LEDs blink when changing the measurement range
Creepage distance and clearance (according to IEC/EN 60664-1)	<ul style="list-style-type: none"> ▪ 4 kV / 9.4 mm ▪ Pollution degree 3 		
IP degree of protection Terminal block (according to IEC/EN 60529)	IP20		
IP degree of protection Housing (according to IEC/EN 60529)	IP30		
IP degree of protection Front face (according to IEC/EN 60529)	IP50		
Vibration resistance (according to IEC/EN 60255-21-1)	<ul style="list-style-type: none"> ▪ 20 m/s² ▪ 10 Hz → 150 Hz 		
Relative humidity no condensation (according to IEC/EN 60068-2-30)	2 x 24 hr cycle 95 % RH max. without condensation 55 °C		
Electromagnetic compatibility - Immunity to electrostatic discharges (according to IEC/EN 61000-4-2)	Level III (Air 8 kV / Contact 6 kV)		
Immunity to radiated, radio-frequency, electromagnetic field (according to IEC/EN 61000-4-3)	<ul style="list-style-type: none"> ▪ Level I (1 V/m: 2.0 GHz → 2.7 GHz) ▪ Level II (3 V/m: 1.4 GHz → 2.0 GHz) ▪ Level III (10 V/m: 80 MHz → 1 GHz) 		
Immunity to rapid transient bursts (according to IEC/EN 61000-4-4)	Level III (direct 2 kV / Capacitive coupling clamp 1 kV)		
Immunity to shock waves on power supply (according to IEC/EN 61000-4-5)	Level III (2 kV / common mode 2 kV / residual current mode 1 kV)		
Immunity to radio frequency in common mode (according to IEC/EN 61000-4-6)	Level III (10V rms: 0.15 MHz → 80 MHz)		

	H3USN	H3US	M3US
Immunity to voltage dips and breaks (according to IEC/EN 61000-4-11)	<ul style="list-style-type: none"> ▪ 0 % residual voltage, 1 cycle ▪ 70 % residual voltage, 25/30 cycles 		
Mains-borne and radiated emissions (according to EN55032 (CISPR22), EN55011 (CISPR11))	Class B		
Fixing: Symmetrical DIN rail (according to IEC/EN 60715)	35 mm		
Mounting position	All positions		
Drop to concrete floor (according to IEC/EN IEC 60068-2-31)	High: 1m		
Rigid connecting capacity without ferrule	<ul style="list-style-type: none"> ▪ 1 x 4² - 2 x 2.5² mm² ▪ 1 x AWG11 - 2 x AWG14 		
Flexible connecting capacity with ferrule	<ul style="list-style-type: none"> ▪ 1 x 2.5² - 2 x 1.5² mm² ▪ 1 x AWG14 - 2 x AWG16 		
Tightening torque (according to IEC 60947-1)	0.5...0.6N.m		
Housing material (according to IEC/EN 60695-2-11)	<ul style="list-style-type: none"> ▪ Self-extinguishing ▪ Incandescent wire test 		
Shock and bump tests (according to IEC/EN 60255-21-2)	15 g - 11 ms		
Short interruption on power line (according to IEC/EN 61000-4-11)	0% residual voltage, 250/300 cycles		
Delivery: open terminals	True		
Type of electric connection	Screw connection		

Outline Dimensions

Depth (mm)	64.8	69
Height (mm)	90	
Weight (g)	130	80
Width (mm) according to DIN 43880	35	17.5

International Directives & Conformity Certification

RoHS 2015/863/UE	Yes
REACH regulation N°1907/2006/CE	Yes
UK REACH regulation 2023 N°722	Yes
LVD 2014/35/UE	Yes
Directive 2012/19/EU	Yes
European Directive 2005/20/CE	Yes
ISO 14001: 2015	Yes
Certification CE	Yes
Certification UL	Yes
Certification UKCA	Yes
Certification CCC	Yes

Principles

3-phase network control relays monitor:

- Undervoltage, adjustable from -20 to -2 % of Un
- Overvoltage, adjustable from 2 to 20 % of Un
- Presence of the neutral (H3USN only)

Measurements are taken between Phases for the H3US - M3US and between Phases and Neutral for the H3USN

Faults are signalled via LEDs, distinguishing the origin of the fault (one LED for the upper threshold, one LED for the lower threshold).

Voltage selector switch:

Set the selector switch to the 3-phase network voltage Un.

The position of this selector switch is only taken into account when the unit is powered up.

If the switch position changes while the unit is operating, all the LEDs flash but the product continues to work normally with the voltage selected on energisation prior to the change of position.

The LEDs return to their normal state if the switch is reset to its initial position defined before the last energisation.

Operating principles

H3US - H3USN

The relay monitors its own supply voltage.

The relay controls:

- Undervoltage, adjustable from -2 → -20 % of U_n (-2 → -12 % over the 3 x 220 V~ range due to the minimum voltage 194 V~)
- Overvoltage, adjustable from +2 → +20 % (+2 → +10 % over the 3 x 480 V~ range due to the maximum voltage 528 V~).

Each threshold has its own time delay with independent setting between 0.3 and 30 s.

In the event of a voltage fault, the corresponding relay (one undervoltage output/one overvoltage output) opens at the end of the time delay set by the user.

In the event of phase failure, both relays open instantaneously, without waiting for the end of the time delay. The two relay LEDs go out.

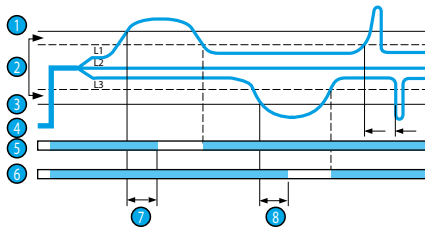

- 1 Overvoltage
- 2 Hysteresis
- 3 Undervoltage
- 4 Phases L1, L2, L3
- 5 Relay R1
- 6 Relay R2
- 7 Overvoltage threshold delay
- 8 Undervoltage threshold delay

M3US

The relay monitors its own supply voltage.

The relay controls:

- Undervoltage, adjustable from -20 → -2 % of U_n (-12 → -2 % over the 3 x 208 V~ range and -17 % → -2 % for the 3 x 220 V~ range due to the minimum voltage 183 V~)
- Overvoltage, adjustable from +2 → +20 % (+2 → +10 % over the 3 x 480 V~ range due to the maximum voltage 528 V~).

An adjustable time delay from 0.3 → 30 s can be used to disable the output relay during a transient fault.

In the event of a voltage fault, the relay opens at the end of the time delay set by the user.

In the event of phase failure, the relay opens instantaneously, without waiting for the end of the time delay.

When the unit is powered up with a measured fault, the relay stays open.

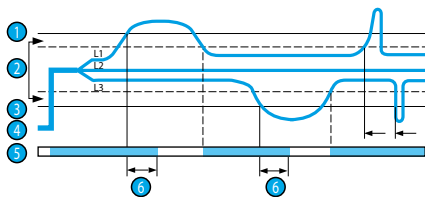

- 1 Overvoltage
- 2 Hysteresis
- 3 Undervoltage
- 4 Phases L1, L2, L3
- 5 Relay
- 6 Over and undervoltage threshold delay

Product Dimensions

Front and Side

H3US-M3US-H3USN

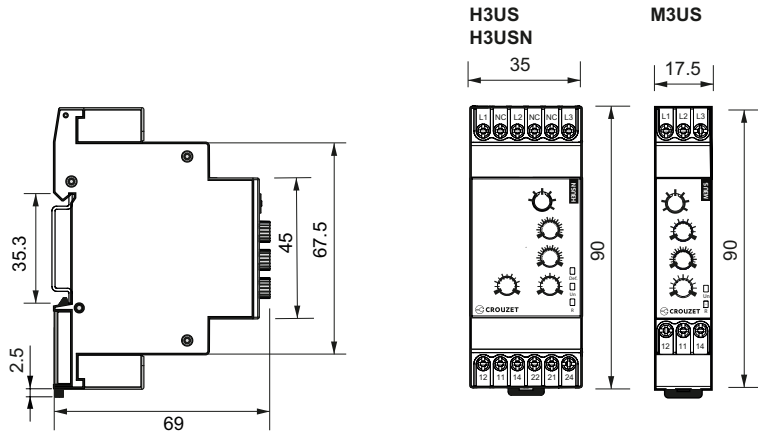

Electronic & Wiring Diagrams

Connections

H3US

M3US

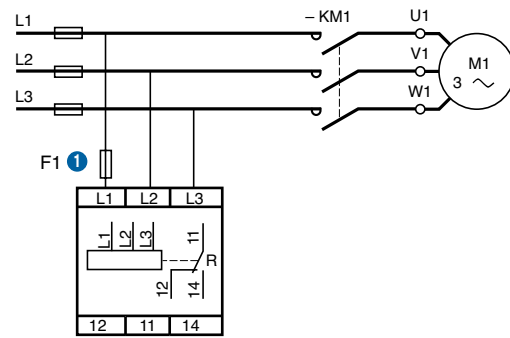
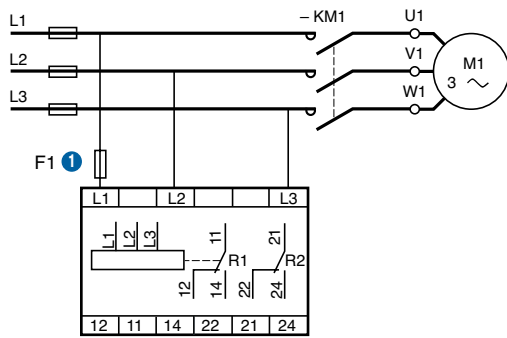

H3USN

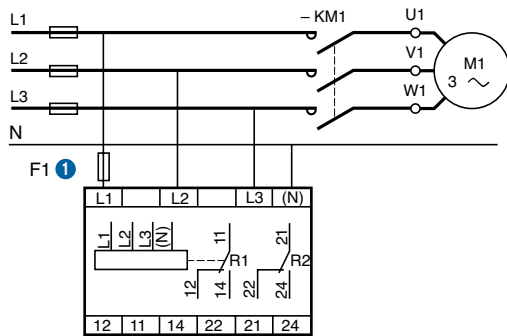

① 100 mA fast-blow fuse or cut-out