

## FUNCTION

Housing Valve seat Poppet Spring

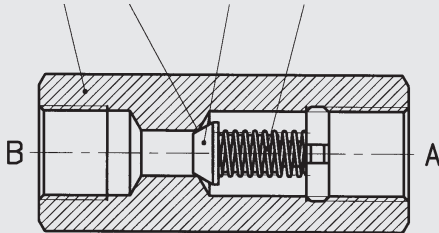

Housing Valve seat Poppet Spring

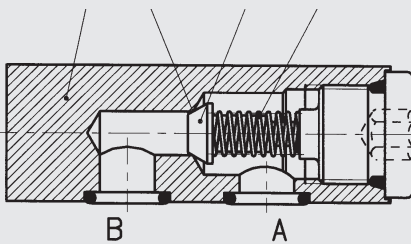

RV and RVP are check valves which allow flow in one direction (port B → port A) while the other direction is shut off. The shut-off function is provided by the spring-loaded cone poppet. The standard cracking pressure is 0.5 bar.

## Check Valves direct-acting, Cone poppet valve for Inline and Manifold Mounting – 350 bar RV-, RVP- 06 to 40

### FEATURES

- Check valves for mounting directly inline and directly onto control manifolds
- Choice of nine sizes ensures best possible adaptability to the system
- Leak-free poppet design for complete shut-off
- Optional zinc-plated version (RVP) available
- Cracking pressures other than 0.5 bar are available as an option

### SPECIFICATIONS\*

Operating pressure:	max. 350 bar	
Nominal flow:	RV, RVP-06	max. 20 l/min
	RV, RVP-08	max. 40 l/min
	RV, RVP-10	max. 70 l/min
	RV, RVP-12	max. 160 l/min
	RV, RVP-16	max. 200 l/min
	RV, RVP-20	max. 350 l/min
	RV, RVP-25	max. 550 l/min
	RV, RVP-30	max. 600 l/min
	RV, RVP-40	max. 600 l/min
Cracking pressure:	0.5 bar	
Media operating temperature range:	min. -20 °C to max. +80 °C	
Ambient temperature range:	min. -20 °C to max. +80 °C	
Operating fluid:	Hydraulic oil to DIN 51524 Part 1, 2 and 3	
Viscosity range:	min. 2.8 mm <sup>2</sup> /s to max. 800 mm <sup>2</sup> /s	
Filtration:	Class 21/19/16 according to ISO 4406 or cleaner	
MTTF <sub>d</sub> :	150 - 1200 years, according to DIN EN ISO 13849-1	
Installation:	No orientation restrictions	
Materials:	Valve body:	steel
	Piston:	hardened and ground steel
	Seals:	FKM (standard)
Weight:	RV 06 = 0.1 kg	RVP 06 = 0.2 kg
	RV 08 = 0.2 kg	RVP 08 = 0.4 kg
	RV 10 = 0.2 kg	RVP 10 = 0.5 kg
	RV 12 = 0.3 kg	RVP 12 = 1.0 kg
	RV 16 = 0.5 kg	RVP 16 = 2.1 kg
	RV 20 = 1.1 kg	RVP 25 = 5.8 kg
	RV 25 = 1.8 kg	RVP 30 = 3.3 kg
	RV 30 = 2.6 kg	RVP 30 = 10.3 kg
	RV 40 = 4.4 kg	RVP 40 = 17.9 kg

\*see "Conditions and instructions for valves" in brochure 53.000

## MODEL CODE

RVP - 08 - 01 . X / 0 - 1 BAR

### Basic model

RV = Check valve for inline mounting  
RVP = Check valve for manifold mounting

### Size

06, 08, 10, 12, 16, 20, 25, 30, 40

### Type

01 = standard (RVP = housing phosphated)  
(RV = housing zinc-plated)  
30 = housing in stainless steel (for RV only)  
Other types on request

### Series

determined by manufacturer

### Threaded connection (for RV only)

0 = Whitworth thread, threaded bore Form X to  
DIN 3852 Part 2  
5 = NPT thread  
12 = UNF thread

### Specific cracking pressure

On request

## Standard models

Model code	Part No.
RV-06-01.X/0	705826
RV-08-01.X/0	705829
RV-10-01.X/0	705832
RV-12-01.X/0	705835
RV-16-01.X/0	705838
RV-20-01.X/0	705841
RV-25-01.X/0	705844
RV-30-01.X/0	705847
RV-40-01.X/0	705850

RVP-06-01.X	705927
RVP-08-01.X	705929
RVP-10-01.X	705931
RVP-12-01.X	705933
RVP-16-01.X	705935
RVP-20-01.X	705937
RVP-25-01.X	705939
RVP-30-01.X	705941
RVP-40-01.X	705943

(Mounting screws are not supplied with the valve)  
Other models on request

Code	Part No.
SEAL KIT 06FKM DV/P DRV/P RVP	555089
SEAL KIT 08FKM DV/P DRV/P DVE RVP SRVR/P	555090
SEAL KIT 10FKM DV/P DRV/P DVE RVP SRVR/P	555091
SEAL KIT 12FKM DV/P DRV/P DVE RVP SRVR/P	555092
SEAL KIT 16FKM DV/P DRV/P DVE RVP SRVR/P	555093
SEAL KIT 20FKM DV/P DRV/P RVP SRV	555094
SEAL KIT 25FKM DV/P DRV/P RVP	555095
SEAL KIT 30FKM DV/P DRV/P RVP	555096

## TYPICAL PERFORMANCE

Pressure drops, dependent on flow rate

RV = Flow direction B → A, measured at  
 $v = 36 \text{ mm}^2/\text{s}$  and  $T_{\text{oil}} = 46^\circ\text{C}$

RVP = Flow direction B → A, measured at  
 $v = 38 \text{ mm}^2/\text{s}$  and  $T_{\text{oil}} = 43^\circ\text{C}$

Pressure differential  $\Delta p$  against flow rate  $Q$ .

### RV-06-01.X to RV-16-01.X

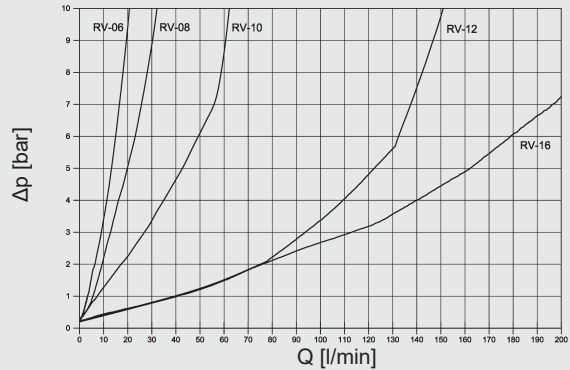

### RV-20-01.X to RV-40-01.X

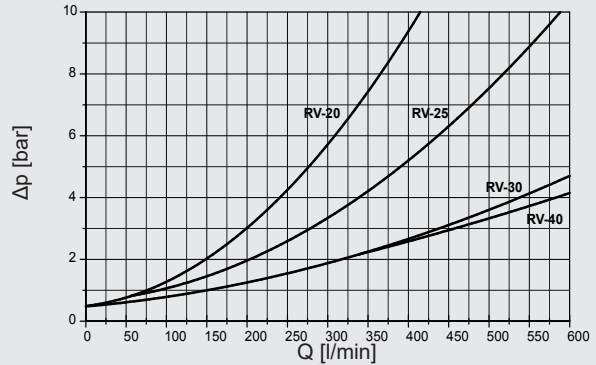

### RVP-06-01.X to RVP-16-01.X

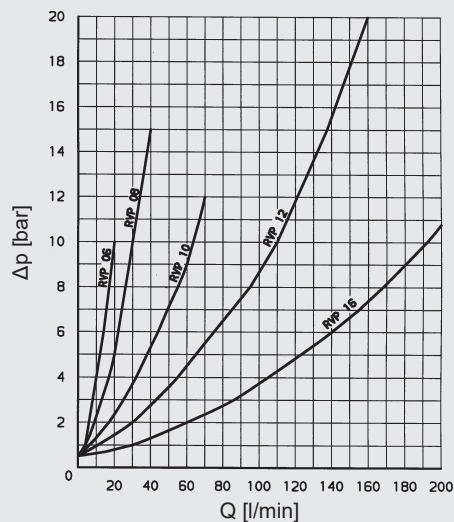

### RVP-20-01.X to RVP-40-01.X

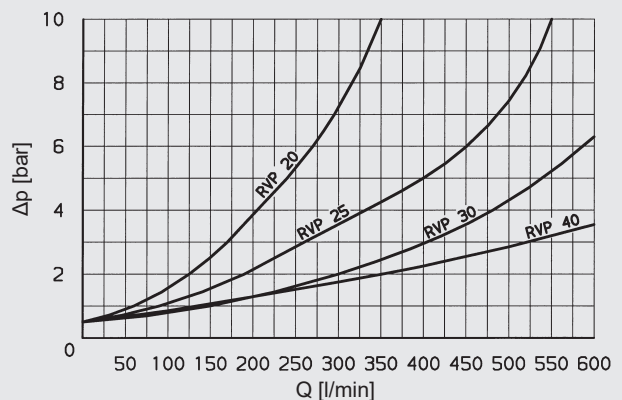

## DIMENSIONS

RV

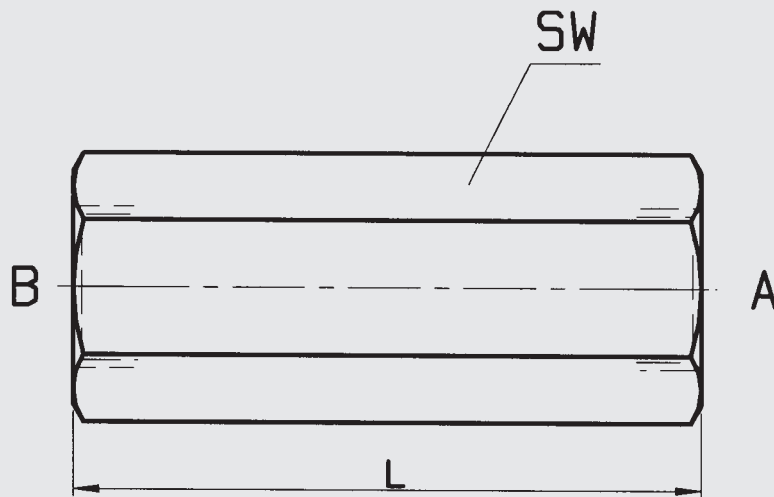

Nominal size	Threaded connection	SW	L	Weight [kg]
06	G1/8	17	45	0.1
08	G1/4	19	55	0.2
10	G3/8	24	65	0.2
12	G1/2	30	73	0.3
16	G3/4	36	88	0.5
20	G1	46	127	1.1
25	G1 1/4	60	143	1.8
30	G1 1/2	65	143	2.6
40	G2	80	165	4.4

RVP

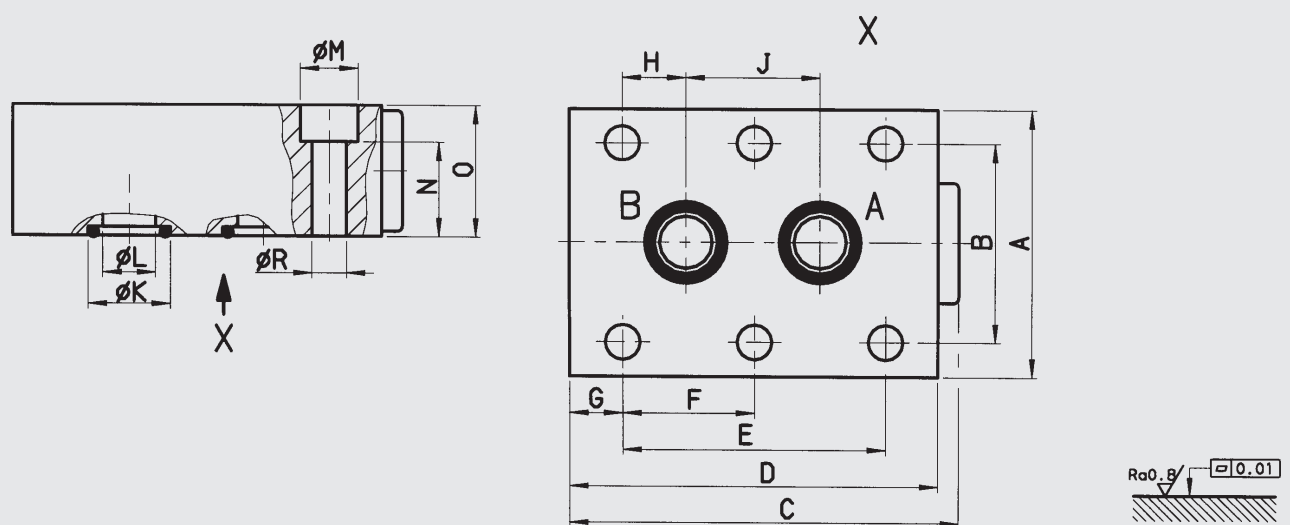

Size	A	B	C	D	E	F	G	H	J	K	L	M	N	O	R	Weight [kg]
06	41.5	28.5	46	41.5	19	–	6.4	1.6	16	9.7	5	11	9	16	6.6	0.2
08	46	33.5	67	63.5	35	–	14.2	4.8	25.5	12.7	7	11	13	20	6.6	0.4
10	51	38	74	70	33.5	–	18	4	25.5	15.6	10	11	18	25	6.6	0.5
12	57.5	44.5	84.5	80	38	–	21	4	30	18.6	13	11	25	32	6.6	1.0
16	70	54	109.5	104	76	38	14	11	54	24.5	17	14	36	45	9	2.1
20	76.5	60	133	127	95	47.5	16	19	57	30.5	22	14	41	50	9	3.3
25	100	76	172	165	120.5	60	15	20.6	79.5	37.4	28.5	18	44	55	11.5	5.8
30	115	92	196	186	143	71.5	15	23.8	95	43.4	35	20	62	75	14	10.3
40	140	111	201	192	133.5	67	16	25	89	57.2	47	20	87	100	14	17.9

## NOTE

The information in this brochure relates to the operating conditions and applications described.  
For applications or operating conditions not described, please contact the relevant technical department.  
Subject to technical modifications.

