

# 4/3 - 4/2 Directional valve elements with or without secondary relief valves, with or without LS connections

L8\_10... (ED1-Z)

**RE 18301-01**

Edition: 09.2018

Replaces: 02.2016

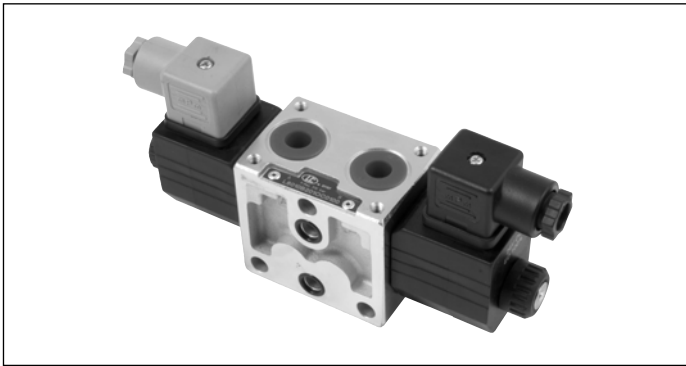

Size 6

Series 00

Maximum operating pressure 310 bar (4500 psi)

Maximum flow 30 l/min (7.9 gpm)

Port connections G 3/8 - SAE6

## General specifications

Valve elements with solenoid operated directional spool. Control spools operated by solenoids with removable coils.

In the de-energized condition, the control spool is held in the central position by return springs.

Wet pin tubes for DC coils, with push rod for mechanical override; nickel plated surface.

Coils can be rotated 360° around the tube; they can be energized by AC current through special connectors with rectifier (RAC).

Manual override (push-button or screw type) available as option.

## Contents

|                                  |    |
|----------------------------------|----|
| Ordering details                 | 2  |
| Symbols                          | 2  |
| Functional description           | 4  |
| Technical data                   | 4  |
| Characteristic curves            | 6  |
| External dimensions and fittings | 7  |
| Electric connection              | 10 |

## Ordering details

|          |          |    |           |     |    |    |    |    |    |
|----------|----------|----|-----------|-----|----|----|----|----|----|
| 01       | 02       | 03 | 04        | 05  | 06 | 07 | 08 | 09 | 10 |
| <b>L</b> | <b>8</b> | -  | <b>10</b> | --- | -- | -- | -  | -  | -- |

### Family

|    |                               |          |
|----|-------------------------------|----------|
| 01 | Directional Valve elements ED | <b>L</b> |
|----|-------------------------------|----------|

### Type

|    |        |          |
|----|--------|----------|
| 02 | Size 6 | <b>8</b> |
|----|--------|----------|

### Configuration

|    |   |          |
|----|---|----------|
| 03 | Standard                                | <b>0</b> |
|    | With secondary valve on A <sup>3)</sup> | <b>1</b> |
|    | With secondary valve on B <sup>3)</sup> | <b>2</b> |
|    | With secondary valves on A and B        | <b>3</b> |
|    | With channels for Load Sensing          | <b>4</b> |

### Coil type

|    |     |           |
|----|-----|-----------|
| 04 | C36 | <b>10</b> |
|----|-----|-----------|

### Spool variants<sup>1)</sup>

|    |                                    |          |
|----|------------------------------------|----------|
| 05 | 4/3 operated on both sides a and b | <b>2</b> |
|    | 4/2 operated on side a only        | <b>3</b> |
|    | 4/2 operated on side b only        | <b>4</b> |

### Voltage supply

|    | 31               | 07 | 03 | 04 | 01 | 00 |           |
|----|------------------|----|----|----|----|----|-----------|
| 06 | Without coil     | -  | -  | -  | -  | ●  | <b>00</b> |
|    | 12V DC           | ●  | ●  | ●  | ●  | -  | <b>OB</b> |
|    | 13V DC           | -  | ●  | -  | ●  | -  | <b>AD</b> |
|    | 24V DC           | ●  | ●  | ●  | ●  | -  | <b>OC</b> |
|    | 27V DC           | -  | ●  | -  | ●  | -  | <b>AC</b> |
|    | 48V DC           | -  | -  | ●  | ●  | -  | <b>OD</b> |
|    | 110V DC          | -  | -  | -  | ●  | -  | <b>OE</b> |
|    | 24V AC (21.5 DC) | -  | -  | -  | ●  | -  | <b>OV</b> |
|    | 110V AC (98 DC)  | -  | -  | -  | ●  | -  | <b>OW</b> |
|    | 230V AC (207 DC) | -  | -  | -  | ●  | -  | <b>OZ</b> |

### Electric connections

|    |   |                         |
|----|---|-------------------------|
| 07 | Without coils   | <b>00</b>               |
|    | With coils, without mating connector DIN EN 175301-803                                | <b>01</b> <sup>5)</sup> |
|    | With coils, with bi-directional diode, without mating connector vertical Amp-Junior   | <b>03</b>               |
|    | With coils, with bi-directional diode, without mating connector horizontal Amp-Junior | <b>04</b>               |
|    | With coils, with bi-directional diode, without mating connector DT04-2P               | <b>07</b>               |
|    | With coils and bipolar sheathed lead 350mm (13,8 in) long with bi-directional diode   | <b>31</b>               |

### Ports

|    |                        |          |
|----|------------------------|----------|
| 08 | G 3/8 DIN 3852         | <b>0</b> |
|    | 9/16-18 UNF 2-B (SAE6) | <b>1</b> |

### Secondary valves setting

|    |                             |                        |
|----|-----------------------------|------------------------|
| 09 | 50-210 bar (725-3045 psi)   | <b>0</b> <sup>4)</sup> |
|    | 100-310 bar (1450-4500 psi) | <b>1</b>               |
|    | 25-50 bar (362-725 psi)     | <b>2</b>               |
|    | 50-100 bar (725-1450 psi)   | <b>3</b>               |

### Options

|    |  |                |
|----|--|----------------|
| 10 | No options                               | <b>No code</b> |
|    | Lever type manual override <sup>2)</sup> | <b>--</b>      |
|    | Push-button type manual override         | <b>0P</b>      |
|    | Screw type manual override               | <b>0F</b>      |

● = Available    - = Not available

### Symbols

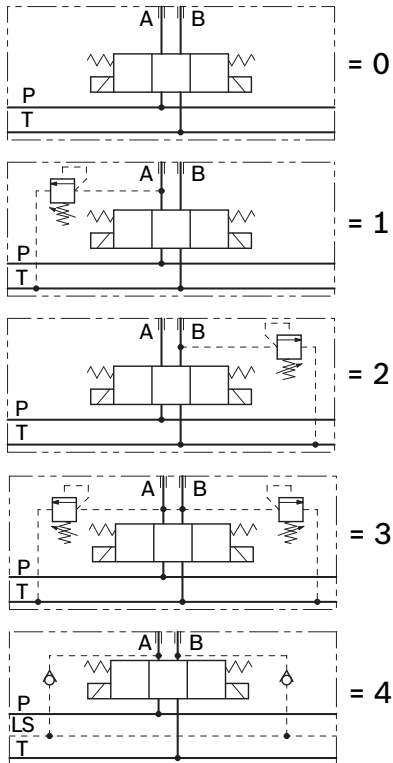

- 1) The required hydraulic symbol and spool variant can be chosen by consulting page 3.
- 2) Available only for A, B, E and F spool configurations. See page 9 for code details.
- 3) The secondary valves have a maximum flow capacity of 6 l/min (1.6 gpm).
- 4) Without secondary valves (versions L80\_; L84\_), the standard configuration corresponds to "0".
- 5) For connectors ordering code see data sheet RE 18325-90.

**Spool variants**

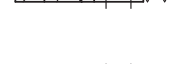
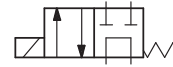
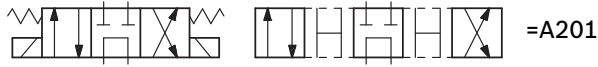
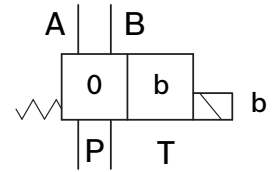
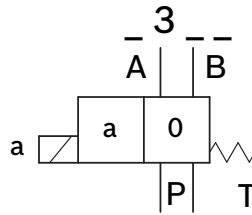
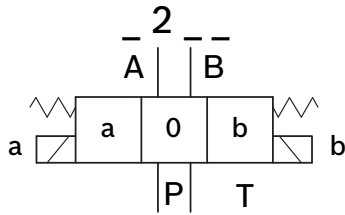

## Functional description

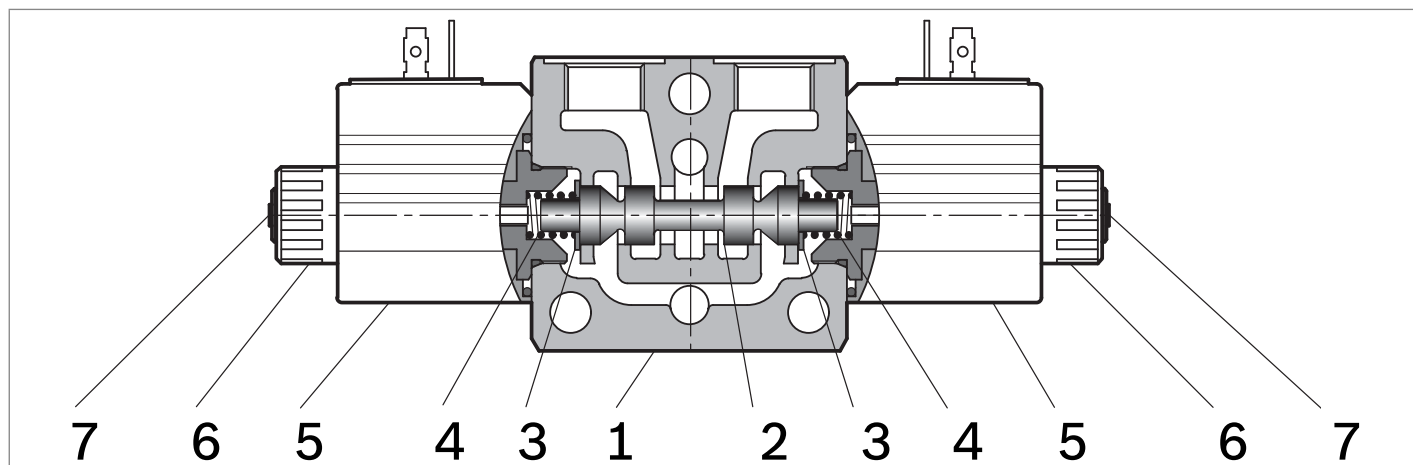

The sandwich plate design directional valve elements L8\_10... are compact direct operated solenoid valves which control the start, the stop and the direction of the oil flow. These elements basically consist of a stackable housing (1) with a control spool (2), one or two solenoids (5), and one or two return springs (4).

When energized, the force of the solenoid (5) pushes the control spool (2) from its neutral-central position “0” to the required end position “a” or “b”, and the required flow from

P to A (with B to T), or P to B (with A to T) is achieved. Once the solenoid is de-energized, the return spring (4) pushes the spool thrust washer (3) back against the housing and the spool returns in its neutral-central position.

Each coil is fastened to the solenoid tube by a ring nut (6). A pin (7) allows to push the spool (2) in emergency conditions, when the solenoid cannot be energized, like in case of voltage shortage.

## Technical data

| General   |                    |   |
|---|--------------------|---|
| Valve element with 2 solenoids  | kg (lbs)           | 1.55 (3.42)   |
| Valve element with 1 solenoid   | kg (lbs)           | 1.25 (2.76)   |
| Valve element with 2 solenoids, with lever type emergency   | kg (lbs)           | 1.9 (4.2)   |
| Valve element with 1 solenoid, with lever type emergency  | kg (lbs)           | 1.6 (3.5)   |
| Ambient Temperature   | °C (°F)            | -20...+50 (-4...+122) (NBR seals)   |
| MTTFd   |                    | 150 years see RE 18350-51   |
| Hydraulic   |                    |   |
| Maximum pressure at P, A and B ports  | bar (psi)          | 310 (4500)  |
| Maximum pressure at T   | bar (psi)          | 250 (3625)  |
| Max pressure, with lever type emergency at T  | bar (psi)          | 200 (2900)  |
| Maximum inlet flow  | l/min (gpm)        | 30 (7.9)  |
| Hydraulic fluid   |                    | Mineral oil based hydraulic fluids HL (DIN 51524 part 1).<br>Mineral oil based hydraulic fluids HLP (DIN 51524 part 2).<br>For use of environmentally acceptable fluids (vegetable or polyglycol base) please consult us. |
| General properties: it must have physical lubricating and chemical properties suitable for use in hydraulic systems such as, for example: |                    |   |
| Fluid Temperature   | °C (°F)            | -20...+80 (-4...+176) (NBR seals)   |
| Permissible degree of fluid contamination   |                    | ISO 4572: $\beta_{x \geq 75} X = 12 \dots 15$<br>ISO 4406: class 20/18/15<br>NAS 1638: class 9  |
| Viscosity range   | mm <sup>2</sup> /s | 5...420   |

| <b>Electrical</b>                         |  |              |      |      |      |      |      |                      |                     |                      |
|---|--|--------------|------|------|------|------|------|----------------------|---------------------|----------------------|
| Voltage type                              | DC (AC only with RAC connection)                             |              |      |      |      |      |      |                      |                     |                      |
| Voltage tolerance (nominal voltage)       | %  | -10 .... +10 |      |      |      |      |      |                      |                     |                      |
| Duty                                      | Continuous, with ambient temperature ≤ 50°C (122°F)          |              |      |      |      |      |      |                      |                     |                      |
| Coil wire temperature not to be exceeded  | °C (°F)  | 150 (302)    |      |      |      |      |      |                      |                     |                      |
| Insulation class                          | H  |              |      |      |      |      |      |                      |                     |                      |
| Compliance with                           | Low Voltage Directive LVD 73/23/EC (2006/95/EC), 2004/108/EC |              |      |      |      |      |      |                      |                     |                      |
| Coil weight with connection EN 175301-803 | kg (lbs)   | 0.215 (0.44) |      |      |      |      |      |                      |                     |                      |
| Voltage                                   | V  | 12           | 13   | 24   | 27   | 48   | 110  | 24<br>+RAC<br>(21,5) | 110<br>+RAC<br>(98) | 230<br>+RAC<br>(207) |
| Voltage type                              |  | DC           | DC   | DC   | DC   | DC   | DC   | DC                   | DC                  | DC                   |
| Power consumption                         | W  | 26           | 26   | 26   | 26   | 26   | 26   | 29                   | 29                  | 29                   |
| Current (nominal at 20 °C (68 °F))        | A  | 2.15         | 2.00 | 1.10 | 1.00 | 0.54 | 0.27 | 1.20                 | 0.29                | 0.14                 |
| Resistance (nominal at 20 °C (68 °F))     | Ω  | 5.5          | 6.5  | 22   | 28   | 89   | 413  | 18                   | 338                 | 1430                 |

**Note**

For applications with different specifications consult us

| Code   | Voltage [V] | Connector type                   | Coil description | Marking | Coil Mat no. |
|--------|-------------|----------------------------------|------------------|---------|--------------|
| =OB 01 | 12 DC       | EN 175301-803<br>(Ex. DIN 43650) | C3601 12DC       | 12 DC   | R933000044   |
| =OB 03 | 12 DC       | AMP JUNIOR                       | C3603 12DC       | 12 DC   | R933000047   |
| =OB 04 | 12 DC       | AMP JUNIOR Horizontal            | C3604 12DC       | 12 DC   | R933002913   |
| =OB 07 | 12 DC       | DEUTSCH DT 04-2P                 | C3607 12DC       | 12 DC   | R933000048   |
| =OB 31 | 12 DC       | Cable 350 mm long                | C3631 12DC       | 12 DC   | R933000045   |
| =AD 01 | 13 DC       | EN 175301-803<br>(Ex. DIN 43650) | C3601 13DC       | 13 DC   | R933000051   |
| =AD 07 | 13 DC       | DEUTSCH DT 04-2P                 | C3607 13DC       | 13 DC   | R933000049   |
| =OC 01 | 24 DC       | EN 175301-803<br>(Ex. DIN 43650) | C3601 24DC       | 24 DC   | R933000053   |
| =OC 03 | 24 DC       | AMP JUNIOR                       | C3603 24DC       | 24 DC   | R933000057   |
| =OC 04 | 24 DC       | AMP JUNIOR Horizontal            | C3604 24DC       | 24 DC   | R933002914   |
| =OC 07 | 24 DC       | DEUTSCH DT 04-2P                 | C3607 24DC       | 24 DC   | R933000058   |
| =OC 31 | 24 DC       | Cable 350 mm long                | C3637 24DC       | 24 DC   | R933000055   |
| =AC 01 | 27 DC       | EN 175301-803<br>(Ex. DIN 43650) | C3601 27DC       | 27 DC   | R933000056   |
| =AC 07 | 27 DC       | DEUTSCH DT 04-2P                 | C3607 27DC       | 27 DC   | R933000050   |
| =OD 01 | 48 DC       | EN 175301-803<br>(Ex. DIN 43650) | C3601 48DC       | 48 DC   | R933000059   |
| =OD 04 | 48 DC       | AMP JUNIOR Horizontal            | C3604 48DC       | 48 DC   | R933002915   |
| =OE 01 | 110 DC      | EN 175301-803<br>(Ex. DIN 43650) | C3601 110DC      | 110 DC  | R933000061   |
| =OV 01 | 24 RAC      | EN 175301-803<br>(Ex. DIN 43650) | C3601 21.5DC     | 21.5 DC | R933000054   |
| =OW 01 | 110 RAC     | EN 175301-803<br>(Ex. DIN 43650) | C3601 98DC       | 98 DC   | R933000060   |
| =OZ 01 | 230 RAC     | EN 175301-803<br>(Ex. DIN 43650) | C3601 207DC      | 207 DC  | R933000062   |

### Characteristic curves

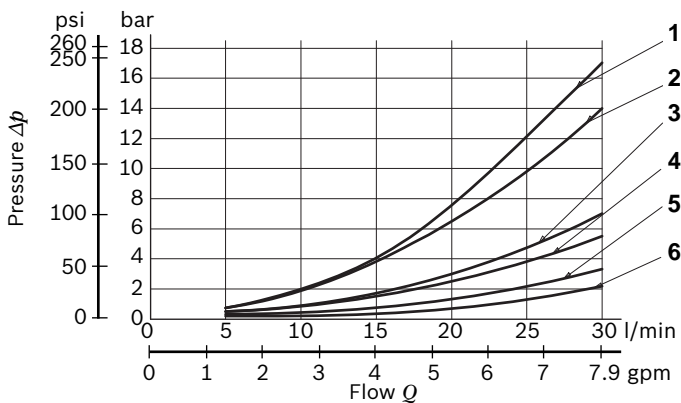

| Spool Variant    | Curve no. |     |     |     |     |
|------------------|-----------|-----|-----|-----|-----|
|                  | P>T       | P>A | P>B | A>T | B>T |
| A201, A301, A401 | 3         | 2   | 2   | 1   | 1   |
| X301, X401       |           | 4   | 4   | 5   | 5   |
| Y301, Y401       |           | 4   | 4   | 5   | 5   |
| B201, B301, B401 |           | 5   | 5   | 5   | 5   |
| C201, C301, C401 | 5         | 4   | 4   | 6   | 6   |
| D201, D301, D401 |           | 5   | 5   | 4   | 4   |
| E201, E301, E401 |           | 4   | 4   | 6   | 6   |
| N301, N401       |           | 4   | 4   |     |     |
| K201, K209       |           | 4   | 4   | 4   | 4   |

Measured with hydraulic fluid ISO-VG32 at 45° ±5 °C (113° ±9 °F); ambient temperature 20 °C (68 °F).

### Performance limits

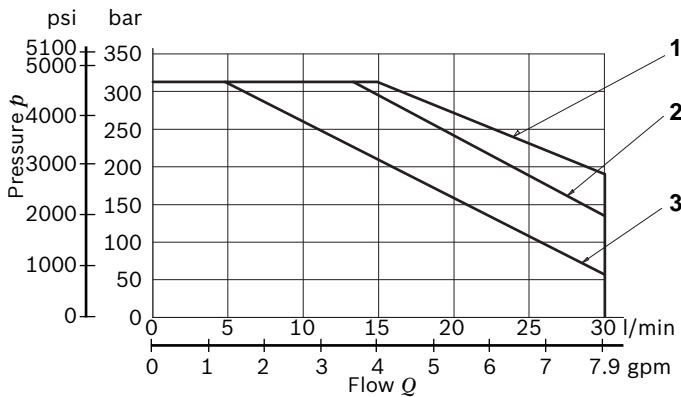

| Spool Variant   | Curve no. |
|---|-----------|
| A201-A301-A401-B201-B301-B401-Y401-X401-X301-Y301-C201-C301-C401-D201-D301-D401 | 1         |
| K201-E201-E301-E401   | 2         |
| N301, N401  | 3         |

The performance curves are measured with flow going across and coming back, like P>A and B>T. With “lever type” emergency control, the performance limits are slightly lower.

### Minimum flow for efficiency of LS control

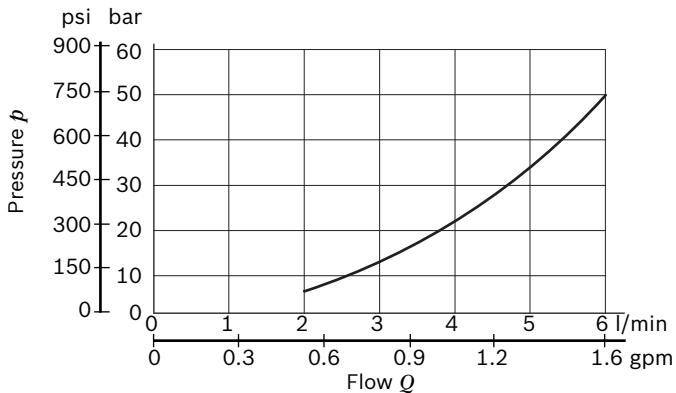

### Lowest pressure setting curve for secondary valves

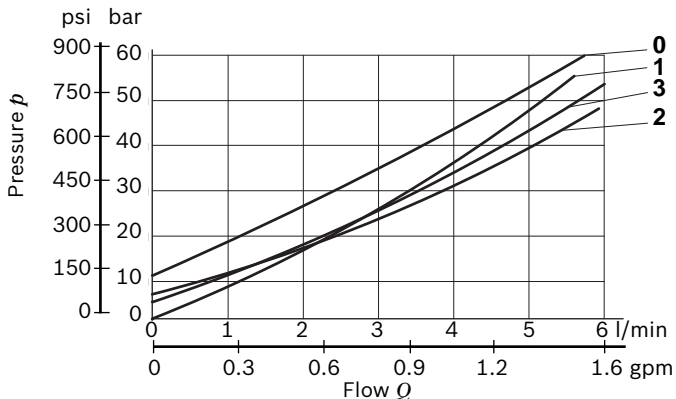

| Secondary valve setting     | Curve no. |
|-----------------------------|-----------|
| 50-210 bar (700-2950 psi)   | 0         |
| 100-310 bar (1400-4500 psi) | 1         |
| 25-50 bar (350-700 psi)     | 2         |
| 50-100 bar (700-2950 psi)   | 3         |



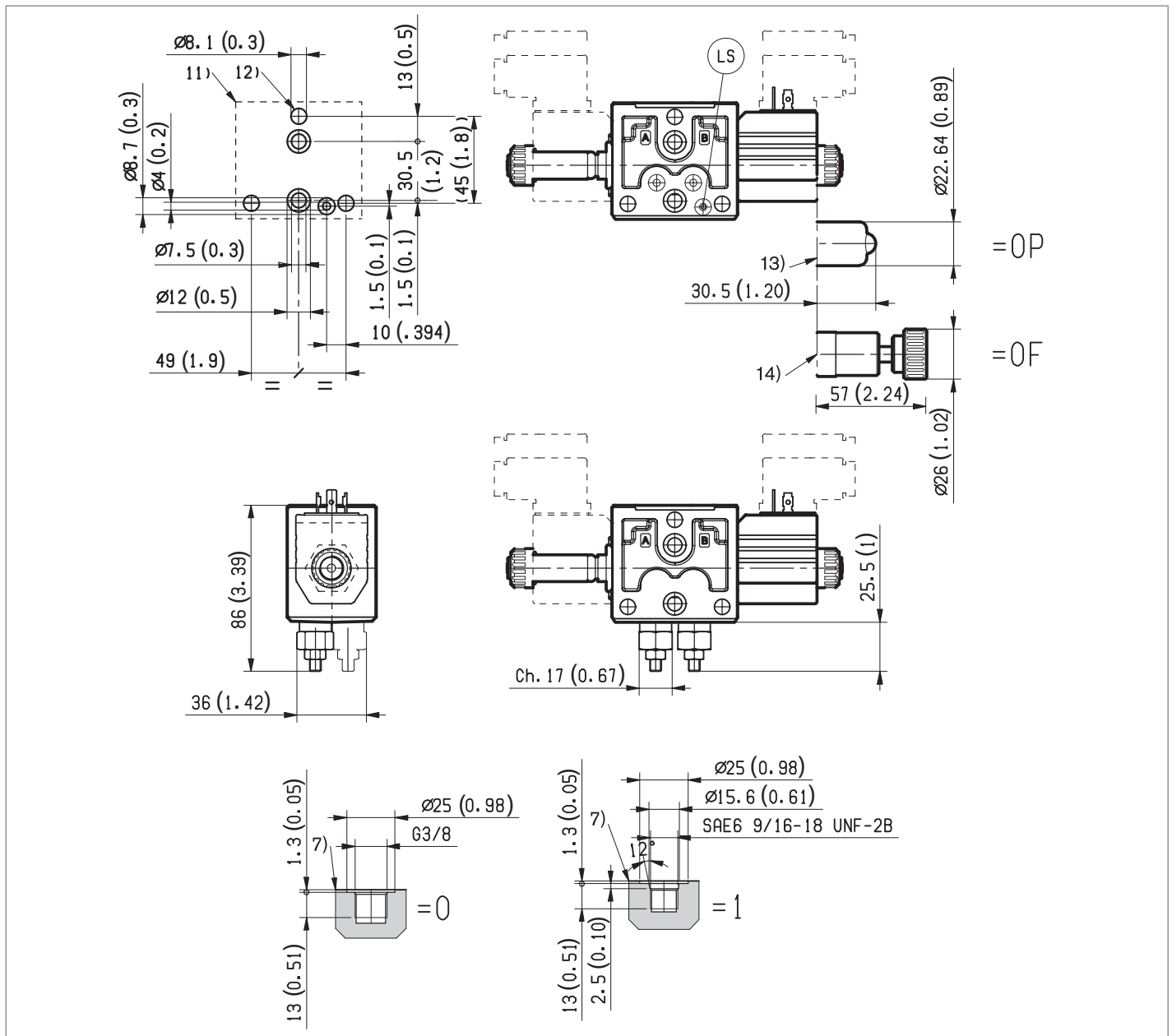

- 11** Flange specifications for coupling to ED intermediate elements.
- 12** For tie rod and tightening torque information see data sheet RE 18301-90.
- 13** Optional push-button manual override, OP type, for spool opening: it is pressure stuck to the ring nut for coil locking. Mat no. R933000042.
- 14** Optional screw type manual override, OF type, for spool opening: it is screwed (torque 6-7 (4.4-5.2 ft-lb)) to the tube as replacement of the coil ring nut. Mat no. R933000021..

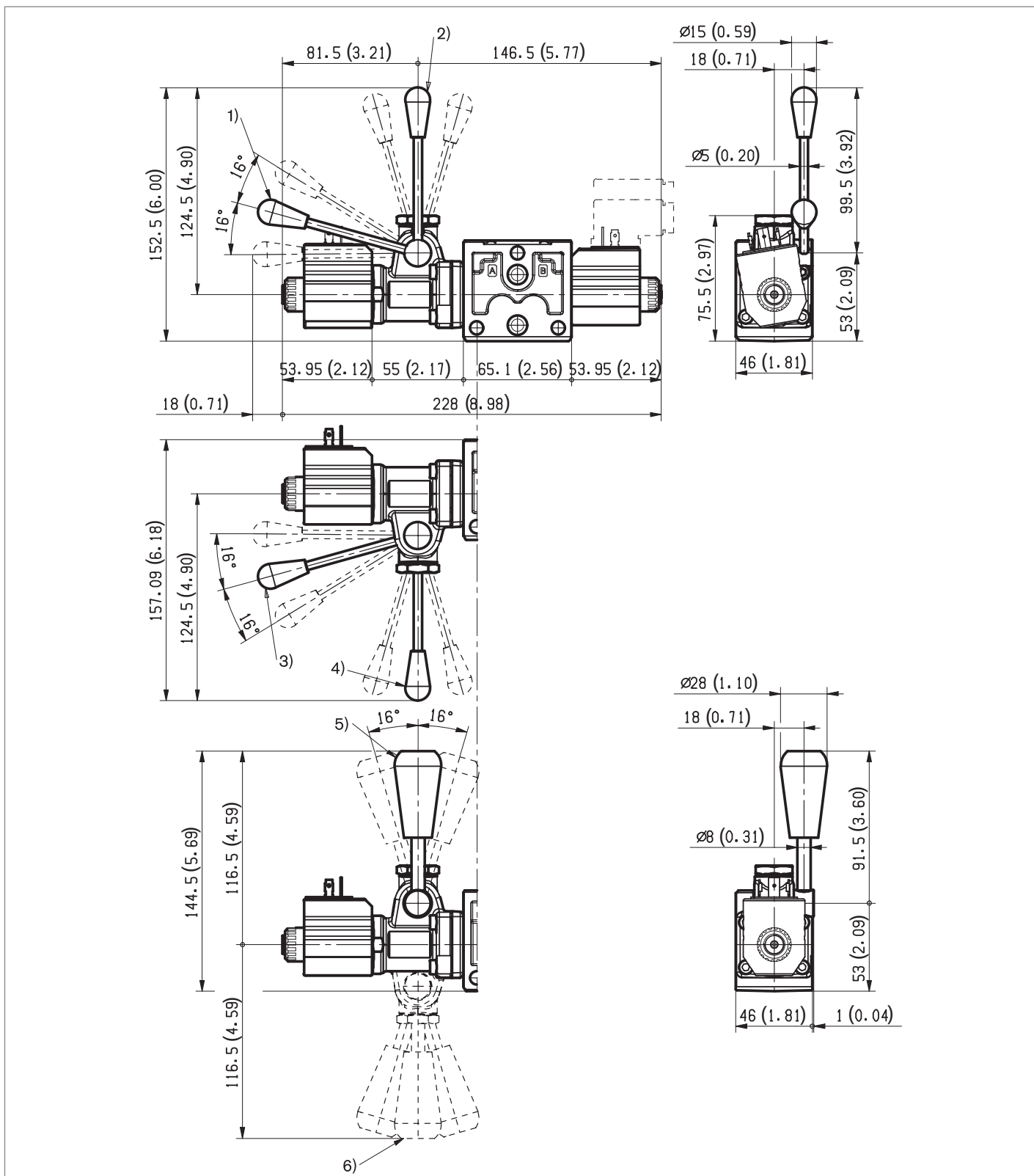

- 1** Ordering Details: HA (if fitted to side A) or HB (if fitted to side B)
- 2** Ordering Details: VA (if fitted to side A) or VB (if fitted to side B)
- 3** Ordering Details: H1 (if fitted to side A) or H9 (if fitted to side B)

- 4** Ordering Details: V1 (if fitted to side A) or V9 (if fitted to side B)
- 5** Ordering Details: XA (if fitted to side A) or XB (if fitted to side B)
- 6** Ordering Details: X1 (if fitted to side A) or X9 (if fitted to side B)

**Electric connection**

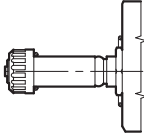
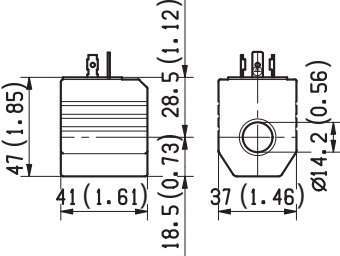
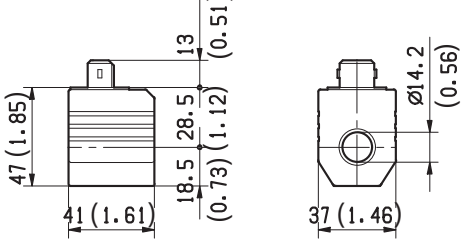
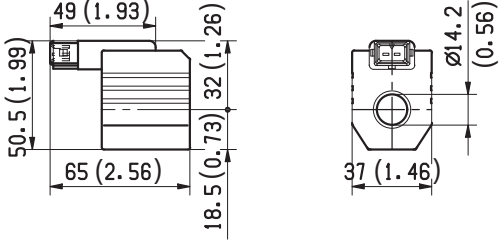
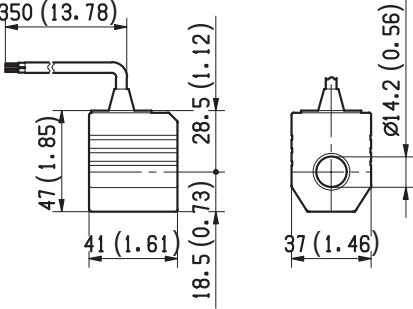
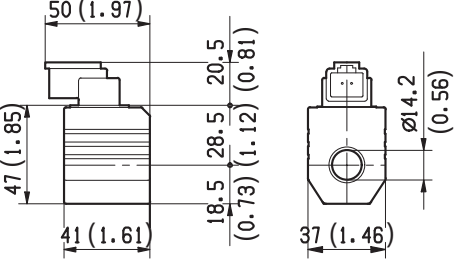
|   |  |
|---|--|
| <p><b>00</b></p>   | <p><b>01</b></p>   |
| <p><b>03</b> Protection class: IP 65 with female connector properly fitted (see drawing).</p>  | <p><b>04</b> Protection class: IP 65 with female connector properly fitted (see drawing).</p>      |
| <p><b>31</b></p>   | <p><b>07</b> Protection class: IP 69 K with female connector properly fitted (see drawing).</p>  |