

Solenoid operated valves pilot operated poppet type
2-way normally open
Common cavity, Size 08

VEI-16-08A-NA

OD.15 - X - 18 - Y - Z - 00

RE 18323-26

Edition: 04.2018

Replaces: 02.2018



PATENT PENDING

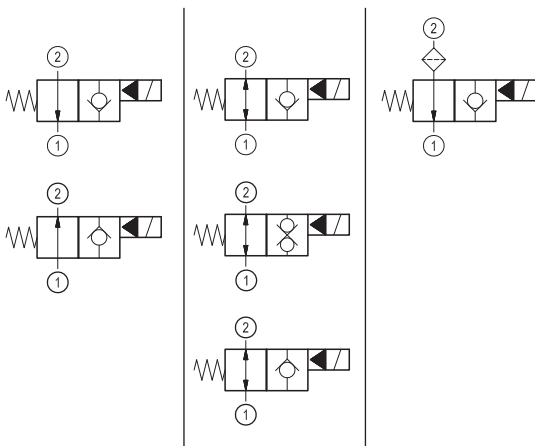
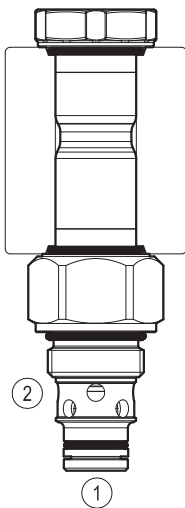

Technical data

New VEI-16 family incorporates a new solenoid concept providing excellent performance and enables cartridges to work in severe environment. Cartridges also incorporates advanced design of hydraulic parts providing excellent hydraulic performance.

Technical data

General	
Weight	0.15 kg (0.33 lbs)
Installation orientation	Unrestricted
Ambient temperature range	-30 to 90 °C (-22 to 194 °F)
Hydraulic	
Max. operating pressure	350 bar (5000 psi)
Flow range	0.5 - 40 l/min (0.1 - 11 gpm)
Fatigue cycle life	2 million cycles at 350 bar 150000 cycles at 420 bar
Max. internal leakage:	5 drops/min. for X= 02,06,08 20 drops/min. for X= 32,10,04
Switching time	Closing ≤ 100 ms Opening ≤ 30 ms
Fluid temperature range	-20 to 80 °C (-4 to 176 °F)
Fluids: Mineral-based or synthetics with lubricating properties at viscosities of 20 to 380 mm ² /s (cSt)	
Installation torque	39 - 51 Nm (29 - 38 ft-lbs)
Recommended degree of fluid contamination	Nominal value max. 10 µm (NAS 8) ISO 4406 19/17/14
MTTFd	150 years see RE 18350-51
Cavity	CA-08A-2N see 18325-70
Seal kit for X=02,06,08	code RG08A2010520100 material no. R901101437
Seal kit for X=32,10,04	code RG08A2010530100 material no. R901101544
Seal kit coil and standard cap	code RG02Z0010000100 material no. R930067869
Seal kit coil and protective cap only for Y=B	code RG03Z0010000100 material no. R930067870
Seal kit coil and protective cap only for Y=C	code RG04Z0010000100 material no. R930069171
Other technical data	See data sheet 18350-50
Electrical	
Type of voltage	DC voltage
Coil type	D36
Supply voltage	See data sheet 18325-90
Voltage tolerance against ambient temperature	See characteristic curve
Power consumption	20 W
Type of protection	See data sheet 18325-90
Note: Coils must be ordered separately	

Ordering code

OD.15	X	18	Y	Z	0000	*
--------------	----------	-----------	----------	----------	-------------	----------

Solenoid operated valves
pilot operated poppet type
2-way normally open

Series O/A to L
unchanged performances and dimensions

monodirectional type

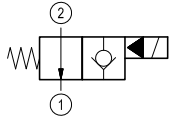

02

bidirectional type

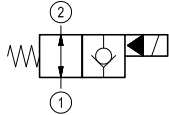

06

monodirectional type with filter

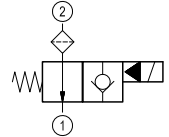

08

bidirectional type

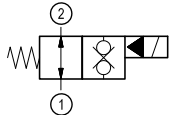

32

monodirectional type

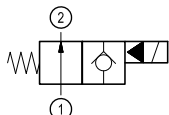

10

bidirectional type

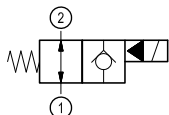

04

0 = With buna seal
V = With Viton seal
P = With buna seal and protective cap for override version **B** and **C**
T = With Viton seal and protective cap for override version **B** and **C**

A = Standard
B = Push style manual override
C = Push and twist style manual override

Common cavity: CA-08A-2N

Preferred types

Type	Material number
OD150218A000000	R930059442
OD150218B000000	R930060895
OD150218BP00000	R930060113
OD150218C000000	R930060584
OD150218CP00000	R930060090
OD150618A000000	R930058435
OD150618B000000	R930058438
OD150618C000000	R930060128
OD150818A000000	R930058337
OD150818B000000	R930058340
OD150818C000000	R930060583

Type	Material number
OD153218A000000	R930064101
OD153218B000000	R930063422
OD153218C000000	R930065002
OD150418A000000	R930065329
OD150418B000000	R930066184
OD150418C000000	R930066185
OD150618CP00000	R930060905
OD153218CP00000	R930065328
OD151018B000000	R930066186
OD151018C000000	R930066187
OD150618AV00000	R930060900

Characteristic curves

All Versions - Admissible supply voltage Vs. Ambient temperature at 100% duty cycle

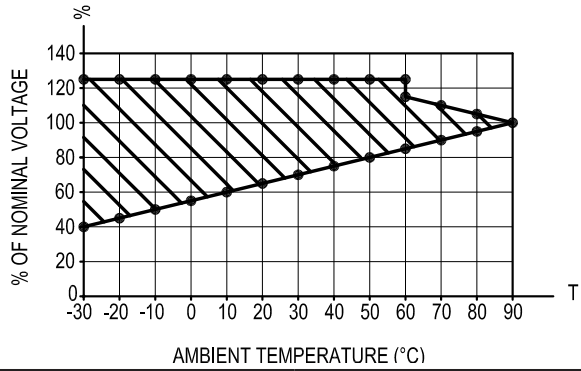

Versions 02, 06, 08

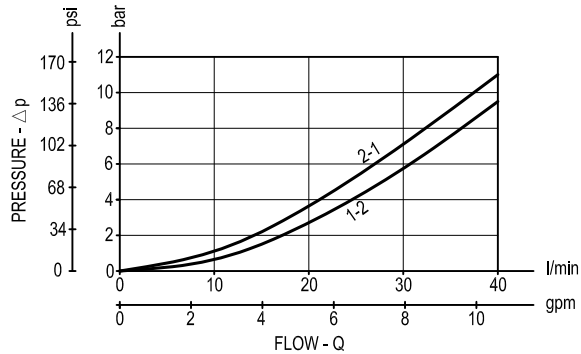

Version 32

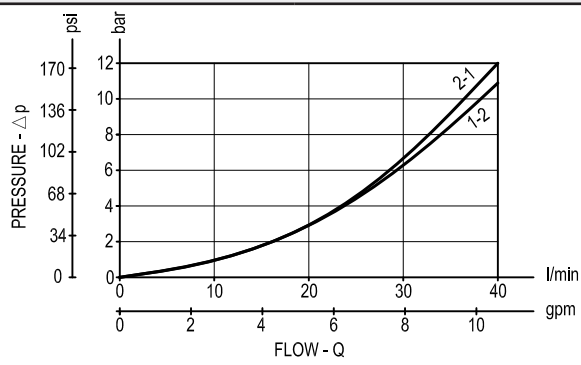

Version 04, 10

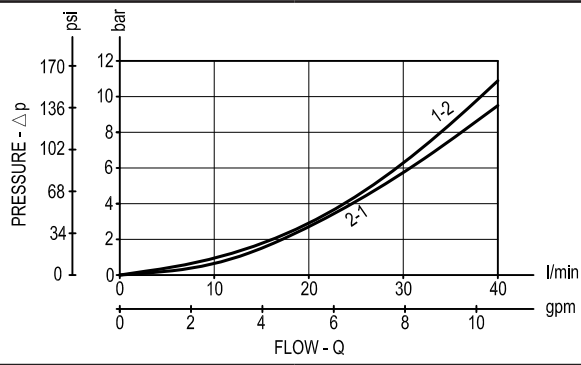

Dimensions

Solenoid operated valves, poppet 2-way normally open

